

CEMINTEL®



BARESTONE™ EXTERNAL  
& SURROUND™ EXTERNAL  
Installation on Timber Battens



## 01

## INTRODUCTION

## TABLE OF CONTENTS

<b>01 INTRODUCTION</b>	<b>2</b>	<b>04 SYSTEM DESIGN</b>	<b>16</b>
<b>02 PRODUCT OVERVIEW</b>	<b>4</b>	System Design	17
Barestone External Panel Information	6	Design Tables – Maximum Timber Batten Span/Fastener Spacing	17
Product Specifications	6	Design Tables – Maximum Cladding Span and Fastener Spacing	18
Spectral Reflectivity Values	6	<b>05 INSTALLATION</b>	<b>20</b>
Surround External Panel Information	8	Installation Procedure	21
Product Specifications/System Solutions	8	<b>06 CONSTRUCTION DETAILS</b>	<b>22</b>
Colour Palette	9	<b>07 SAFETY, HANDLING, GENERAL CARE + WARRANTY</b>	<b>30</b>
Applications	10	Health, Safety and Personal Protection Equipment (PPE)	31
Weather Resistance	10	Safety, Handling, and Maintenance	31
Corrosive Zones	10	Warranty	31
Fire Resistance Performance	11		
Bushfire-Prone Areas	11		
Wash Down Process	12		
Inspection, Repair and Maintenance	12		
<b>03 COMPONENTS + ACCESSORIES</b>	<b>13</b>		

## Introduction

Cemintel Barestone External and Surround External panels combine with timber battens to form a simple, durable system for residential buildings. The use of corrosion resistant materials makes this system suitable for most applications, including coastal environments.

This Installation Guide includes system engineering information and installation procedures for common external cladding applications. Information on general design considerations is given in the Cemintel Facades and Cladding Design Guide.

It is assumed that the user has an expert knowledge of building design and construction. In no way does this guide replace the services of the building professionals required to design projects, nor is it an exhaustive guide of all possible scenarios. It is the responsibility of the architect, designer, and various engineering parties to ensure that the details in this Installation Guide are appropriate for the intended application.

This guide should be read in conjunction with the relevant Cemintel Installation Guide, which provides a comprehensive list of design and aesthetic considerations including panel layout options, structural considerations, moisture management, insulation and energy efficiency, and additional installation details. Reference is also made to the Cemintel soft air barrier and rigid air barrier, further information on the design and installation of these air barriers is presented in the CSR Cemintel Facades & Cladding – Design Guide and the CSR Cemintel Rigid Air Barrier – Design & Installation Guide, respectively.

Whilst this Installation Guide is applicable for use with Cemintel Surround panels, **please note however**, that not all colour matched screws for the Secondary Palette panels are stocked, and lead times apply.

## INTRODUCTION



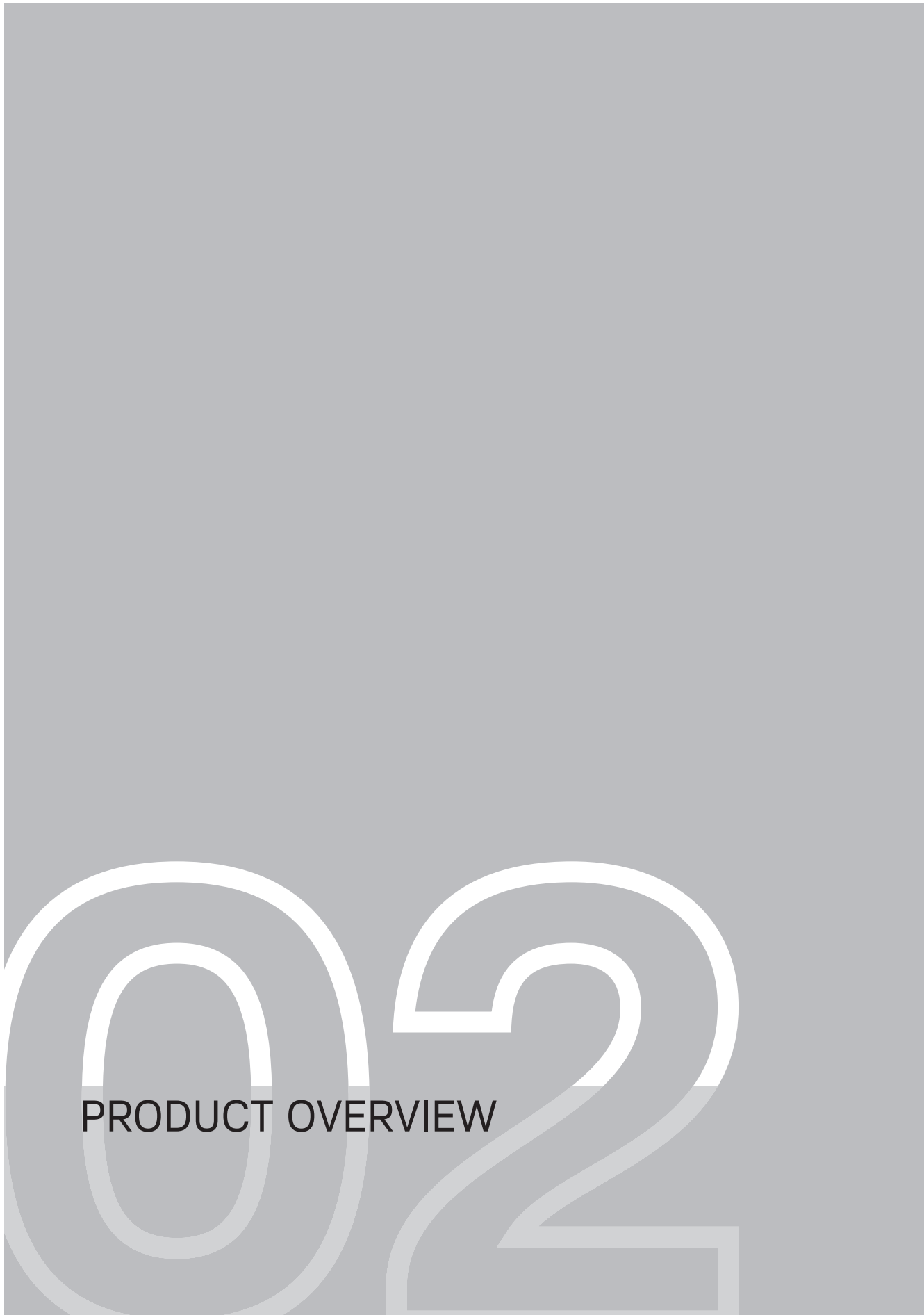

PRODUCT OVERVIEW

## PRODUCT OVERVIEW



FIGURE 2.01 Barestone External and Surround on Timber Battens Overview

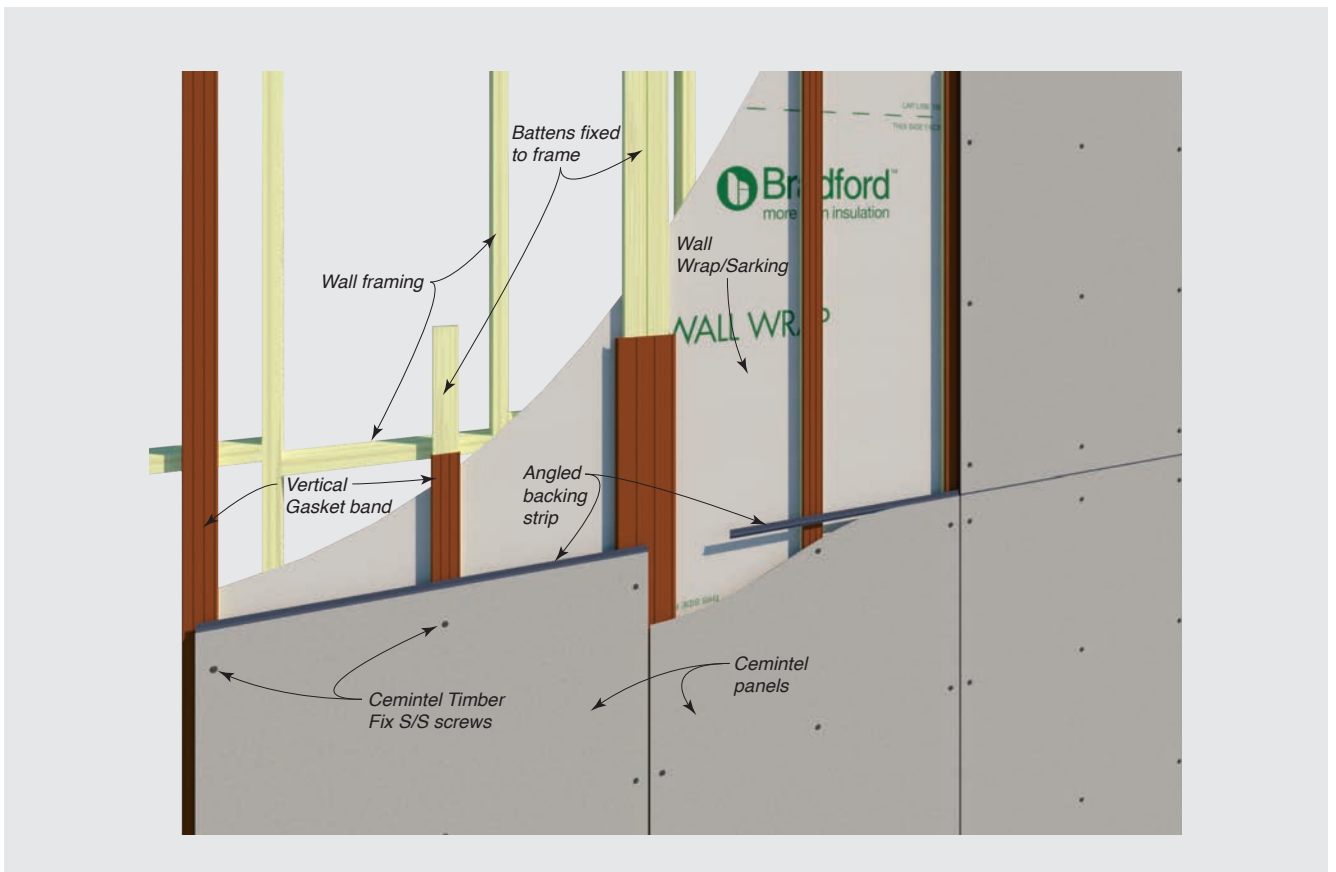

## 02

## PRODUCT OVERVIEW

**Barestone External Panel Information**

Barestone External panels provide a natural, raw appearance that blends seamlessly with its environment and easily adapts to modern, contemporary building designs. Barestone is available in four colours – Original, Ash, Lunar and Graphite. As with natural timber or stone, every piece is unique in colour and patterning, reflecting the qualities of the natural ingredients used in the manufacturing process.

The panels are prefinished, square edged, compressed fibre cement (CFC), consisting primarily of Portland Cement, cellulose fibre, air, and water. They feature Cemintel water-blocking technology and are factory sanded, ready for installation with the Cemintel Expresswall system.

Cemintel Barestone External panels are compressed to produce a dense 9mm panel that offers superior performance in terms of strength and durability, making Barestone External an excellent choice for commercial applications subject to higher wind loads.

Cemintel Barestone External cladding conforms to the requirements of AS/NZS 2908.2 – Cellulose-cement products, Part: 2 – Flat sheets, Category 5, Type A.

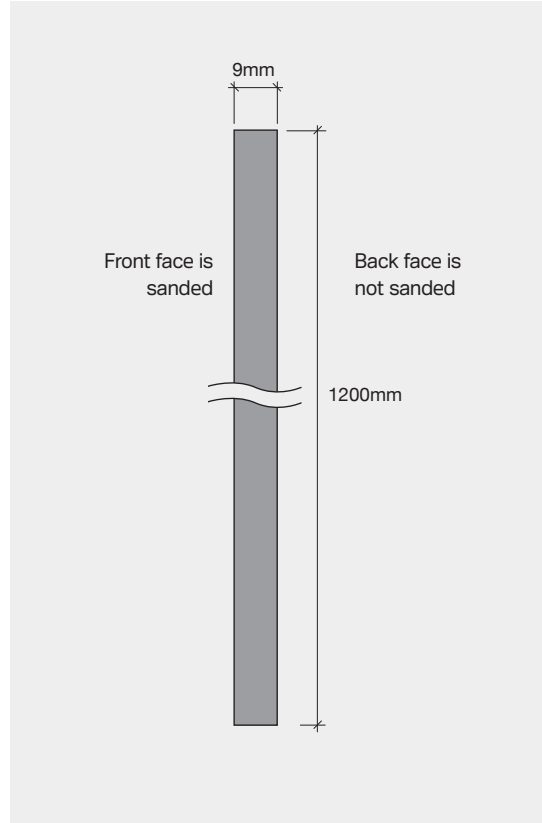
**Product Specifications**

Property	Specification	Manufacturing Tolerance	Relevant Standard
Panel Width	1200mm	+ 0.0mm / - 2.0mm	AS/NZS 2908.2
Panel Length	2400 and 3000mm	+ 0.0mm / - 2.0mm	AS/NZS 2908.2
Panel Thickness	9mm	+ 0.9mm/ - 0.0mm	AS/NZS 2908.2
Panel Mass (EMC)	17.8kg/m <sup>2</sup>		AS/NZS 2908.2

EMC – Equilibrium Moisture Content

**Spectral Reflectivity Values**

Product	Solar Reflectance %	Solar Absorbance %	Basix Colour	Relevant Standard
Barestone Original	39.8	60.2 (+ / - 1.2)	Medium	ASTM E 903

Thickness (mm)	Width (mm)	Length (mm)	Mass (Nominal)	Panels per pack
9	1200	2400	17.8kg/m <sup>2</sup>	20
9	1200	3000	17.8kg/m <sup>2</sup>	20

PRODUCT OVERVIEW



## Surround External Panel Information

Cemintel Surround External panels are prefinished, fibre cement panels that are colour bodied delivering a more natural appearance and depth of colour than can be achieved with a standard surface painted finish. They come trimmed and sealed in a standard 1200 x 3000 x 8mm size\*.

Consisting primarily of Portland Cement, wood pulp, reinforcement fibres, air and water, panels have undergone a longer, natural air curing process and offer superior performance in terms of strength, density and durability, making them an excellent choice for commercial applications subject to higher wind loads.

The range comprises 5 colour groups. Each group has a foundation 'Base' colour and 4 complementary textures/patterns featuring a matte finish. There is also a 'Secondary' palette with colours that work across each range. Panels come with a range of colour matched rivets to provide a more seamless aesthetic finish.

Panels feature a UV protective coating applied during the manufacturing process. Rain water washes contaminants away entailing minimal maintenance, ongoing good looks and superior durability.

Cemintel Surround cladding conforms to the requirements of BS EN 12467:2012 – Fibre-cement flat sheets - Product specification and test methods,

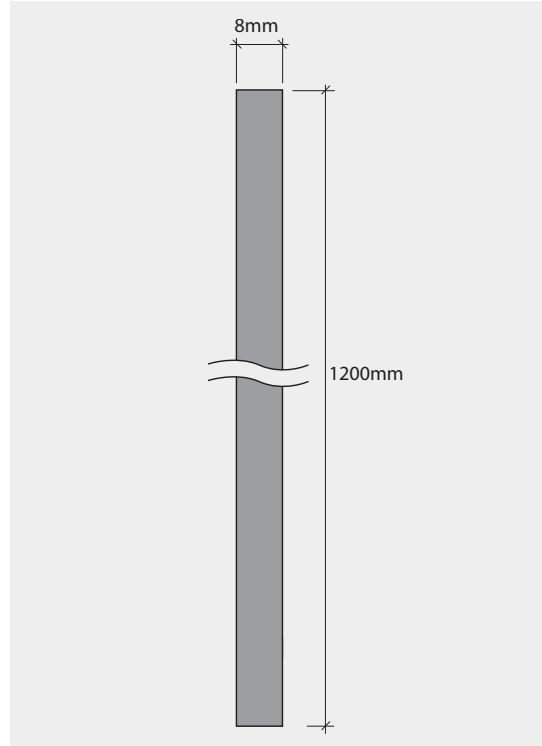

Category A, Class 4. The BS EN 12467 bending strength testing demonstrates the Cemintel Surround External cladding conforms to the requirements of AS/NZS 2908.2 – Cellulose-cement products, Part: 2 – Flat sheets, Category 5, Type A.

\*Lengths up to 3050mm are available as special orders.

## Product Specifications/System Solutions

A technical Data Sheet can be downloaded from [cemintel.com.au](http://cemintel.com.au)

Dimensional/Geometrical Characteristic	Specification (trimmed panel)	Manufacturing Tolerance	Relevant Standard
Panel Width	1200mm	+1.5mm / -1.5mm	AS/NZS 2908.2
Panel Length	3000mm*	+1.5mm / -1.5mm	AS/NZS 2908.2
Panel Thickness	8mm	+0.8mm / -0.8mm	AS/NZS 2908.2
Panel Mass (EMC)	15.7kg/m <sup>2</sup>		

EMC – Equilibrium Moisture Content

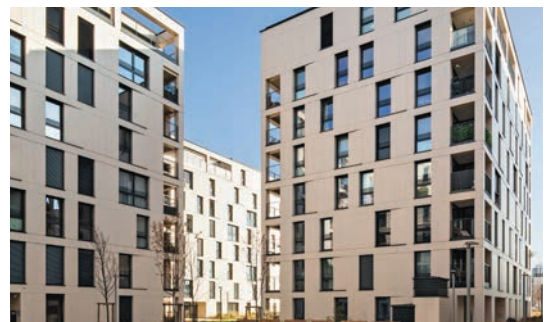



## Colour Palette

Allowing you to mix and match colours with confidence, Surround has a wide range of colours from neutral colours to pop colours.

As Surround is a prefinished product, product images may vary from the actual product in regard to colour and surface finish.

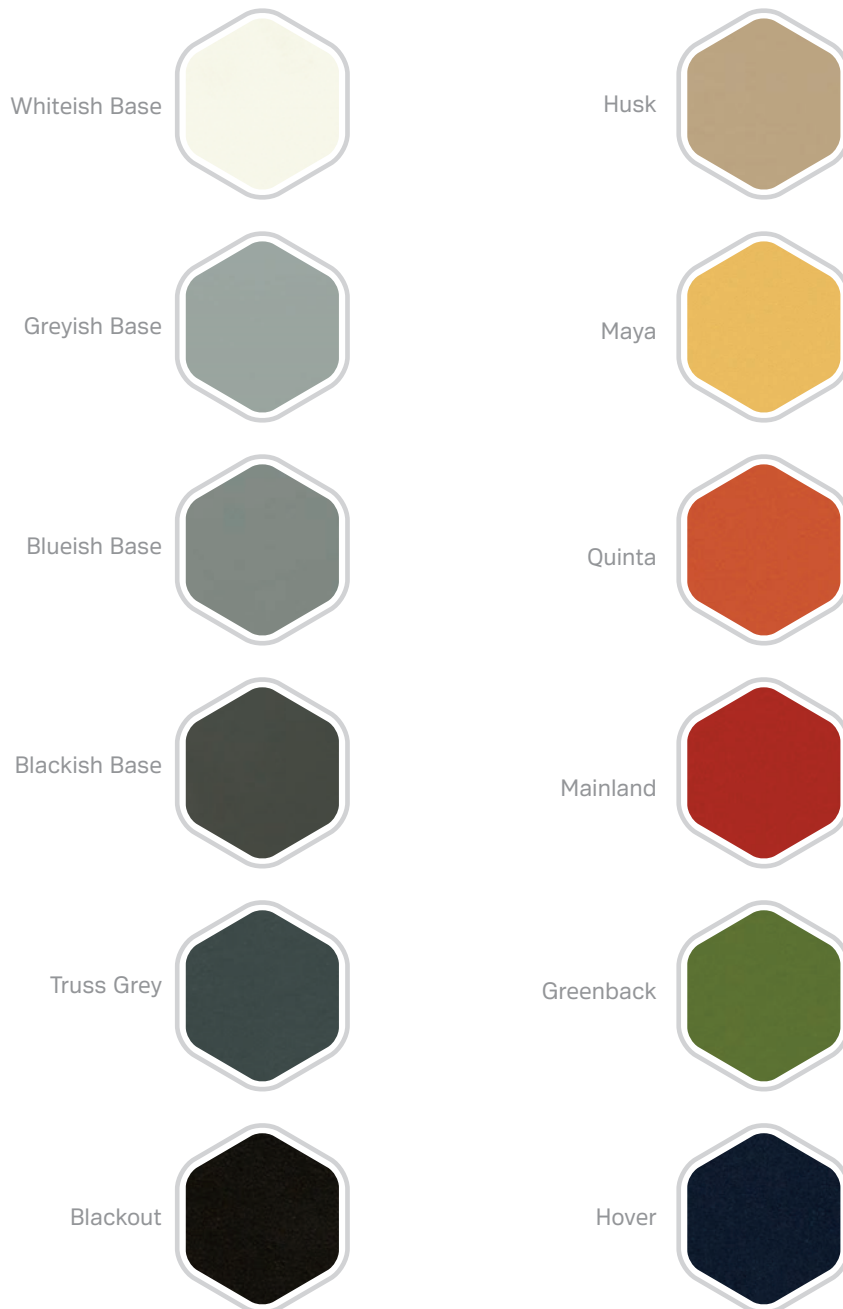

## 02

## PRODUCT OVERVIEW



### Applications

Barestone External and Surround External panels can be used for residential projects in various applications including:

- New home facades and cladding
- Upper and lower storey additions
- Composite construction
- Gable ends
- Infill sheets around windows and doors
- Outbuildings including garages and tool-sheds
- Over-cladding of existing walls
- Ceilings
- Soffits and Eaves

Barestone External and Surround External panels with timber battens are intended for use on timber framed Class 1 and 10 residential buildings in accordance with the relevant Australian Standards and are suitable for wind classifications N1 to N6/C4 in accordance with AS 4055: Wind loads for housing.

### Weather Resistance

The control of water ingress to a building is the responsibility of the building designer. All framing, wall wrap/sarking, flashings, damp proof courses and sealants must be installed in accordance with design and installation guides, the relevant product manufacturer's instructions, applicable standards and building codes. The selection of the appropriate installation system is based on many factors, but particular attention must be paid to weatherproofing to ensure adequate long-term performance.

Cemintel Barestone External and Surround External prefinished panels are installed as part of a pressure equalised system, using vertical timber battens to create a drained, ventilated cavity and an air barrier behind the cladding. The system provides a versatile and durable façade which is suitable for a range of building styles. Panels can be orientated horizontally or vertically with expressed joints and are fixed using stainless steel exposed head screws.

The timber fix system has been assessed with an air barrier formed at the rear of the ventilation cavity using a Rigid Air Barrier or Soft Air Barrier, and a sarking with a separate air barrier layer. In residential construction, the internal plasterboard lining is considered the predominant air barrier in the external wall system.

A wall system with a Cemintel Rigid Air Barrier has been assessed to AS 4284 to withstand water ingress for serviceability limit state wind pressures up to +/- 2.5kPa.

The Soft Air Barrier system formed using the Bradford CW-IT Wall Wrap installed as per Cemintel construction details has been assessed as an air barrier for a maximum design ultimate limit state wind pressures up to +/- 2.5kPa. It is recommended that wall wraps used as an air barrier have an air resistance greater than 0.1 MNs/m<sup>3</sup> when tested to ISO 5636-5.

For a sarking not installed as an air barrier, the timber fix wall system has been assessed to AS 4284 to withstand water ingress for serviceability limit state wind pressures up to

+1.19kPa and -1.79kPa using sarking of equivalent or better strength properties to the Bradford CW Wall Wrap installed in accordance with AS 4200.2:2017 and classified as a water barrier in accordance with AS 4200.1:2017. For external walls, NCC limitations include a risk factor score up to 20, ultimate limit state wind pressure up to 2.5kPa and windows comply with AS 2047. Bradford RW Wall Wrap can be used in low-rise applications only (i.e., Class 1).

The designer must ensure the air barrier is structurally adequate to resist the imposed design wind pressures. The construction details for a soft air barrier or rigid air barrier are presented in the Cemintel Facades and Cladding – Design Guide and the Cemintel Rigid Air Barrier Design & Installation Guide, respectively.

A vertical gasket is placed over each batten to provide added weather resistance, and backing strip is used at horizontal joints to reduce water ingress.

### Corrosive Zones

Corrosivity zones are detailed in AS 4312, and the Architect/ Building Designer is responsible for assessing the site in accordance with the standard and to local conditions. The Barestone and Surround systems on timber battens and timber framing may be used in environmental zones up to and including C5 – Very High. This includes the beachfront in regions of rough seas and surf beaches, and inland for several hundred metres, e.g. around Newcastle extending from 100m to over half a kilometre from the shoreline (high tide line). Barestone External and Surround systems are not suitable for Corrosivity Zone CX – Extreme, which includes areas up to 100m from the shoreline of surf or tropical locations. Cemintel's prefinished panels are not recommended for aggressive industrial areas, such as where the environment may be acidic with a pH of less than 5.

Walls must be sufficiently exposed from above so that rain can perform natural wash-down. Walls which are protected by

## PRODUCT OVERVIEW



soffits must be washed down twice per year to remove salt and debris build up, particularly around window/ door openings, and flashings must direct water away from the building.

The selection of materials used for framing, for flashings, additional fasteners, window frames, and for other façade components must be made with consideration of their performance in the corrosion zone. Note that 'tea-staining' may develop over time on timber fix stainless steel screw heads. This does not affect performance and can be reduced by regular washdown of the façade and fastener heads.

## Fire Resistance Performance

### Fire Rated External Wall Systems

The Cemintel guides and Gyprock The Red Book publications provide design and installation information on the FRL rating of the Barestone External and Surround External wall systems. Along with the Barestone External and Surround External cladding, the fire rated wall systems are achieved with the inclusion of other CSR products, such as, Gyprock fire-resistant plasterboard, and Bradford insulation and sarking/wall wraps.

In accordance with NCC 2022 C2D10 [2019: C1.9] and NCC 2022 H3D2 [2019: 3.7.1.1], the following CSR products are deemed suitable for use wherever a non-combustible material is required, as:

- Cemintel Barestone External and Surround External cladding is a fibre-reinforced cement sheeting material;
- Gyprock fire-resistant products are a plasterboard material; and
- Bradford Enviroseal and Thermoseal products are sarking-type materials that do not exceed 1mm in thickness and have a Flammability Index  $\leq 5$ .

For wall systems requiring non-combustible materials, the combustible component in the wall, such as the Cavity Closer, will have to be substituted with a non-combustible, compatible component of equivalent or better performance.

### Design Fire Requirements

The design engineer is responsible for approving and specifying the wall system solution to ensure compliance with applicable NCC provisions, project specification, Australian Standards and any other regulatory requirements. These may include, but not limited to, the following:

- Nominating the length of fasteners to allow for the extra thickness of the fire-rated linings and maintain fastener capacity and minimum embedment;
- Selection of alternative non-combustible materials;
- Specification of the external fire-resistant lining and fixing requirements; and
- When the internal (room) wall linings that form part of the fire rated wall system, design of the areas where the linings are omitted (such as the junctions of walls, floor and roof framing, in the roof space, and at service penetrations) and determine the necessity of additional treatment such as the provision of Supplementary Fire Zone Protection.

For further information, refer to the Cemintel Facades and Cladding – Design Guide and Gyprock The Red Book publications.

## Bushfire-Prone Areas

### Bushfire Attack Level

A Bushfire Attack Level (BAL) rating is a means of measuring the severity of a building's potential exposure to ember attack, radiant heat and direct flame contact. It is the responsibility of the project designer to assess the bushfire adequacy of the wall system and determine any additional details to satisfy the project bushfire requirements (refer to the NCC, AS 3959 and any other relevant regulatory requirements).

Protection against bushfire attack requires a comprehensive and systematic approach to ensure the construction of the whole wall system is considered, that includes the specification of fire-resistant linings, framing, cavity treatment and other materials (e.g., insulation, external wall cladding), and construction details for the external walls and junctions to neighbouring elements (e.g., eaves, decks and floors). Bushfire zone walls require specific treatments, such as but not limited to, all joints in the external surface material (cladding) of walls shall be covered, sealed, overlapped, backed or butt-jointed, inclusion of a sarking-type material applied over the frame prior to fixing any external cladding, and at all gaps (e.g., vents and weepholes) in external walls shall be screened with a mesh with a maximum aperture of 2mm, made of corrosion-resistant steel or bronze. Also mesh coverings maybe required at the wall head, base, all gaps, eaves and junctions with roofs, etc., to ensure appropriate protection from fire and ember attack.

In accordance with AS 3959, the Cemintel Barestone External sheets comply with the minimum thickness requirements of fibre-cement external cladding of Section 8 Construction Requirements for Bushfire Attack Level 40 (BAL-40) for an external wall. Barestone External wall systems can be suitable for use on buildings constructed in accordance with AS 3959 with a BAL rating up to and including BAL-40.

In accordance with AS 3959, the Cemintel Surround External sheets comply with the minimum thickness requirements of fibre-cement external cladding of Section 8 Construction Requirements for Bushfire Attack Level 29 (BAL-29) for an external wall. Surround External wall systems can be suitable for use on buildings constructed in accordance with AS 3959 with a BAL rating up to and including BAL-29.

Cemintel Barestone External and Surround External wall systems can achieve a 30/30/30 FRL rating (or higher) from the outside with the addition of a suitable Gyprock Fyrchek MR plasterboard lining to the outside of the framing (refer to Gyprock The Red Book 01 Design Guide), and installed according to regulations and AS 3959 Section 9 Construction Requirements for Bushfire Attack Level FZ (BAL-FZ) for an external wall. Note that a 10m setback applies from the edge of the classified vegetation to the building.

## 02

## PRODUCT OVERVIEW

**Wash Down Process**

Panels have been coated with a factory finish. Consequently, where sufficiently exposed, rain can perform a natural wash down of the wall and ongoing maintenance should be limited to occasional rinse down or using a soft cloth or soft brush (like a dust pan brush).

Walls which are protected by soffits above must be washed down twice per year to remove salt and debris build up particularly at joints.

When cleaning the panels the following is recommended –

- Normal dirt can be removed with a soft brush and warm water up to 50 degrees Celsius, to which a small amount of dishwashing liquid or soap has been added. The panels should be rinsed with clear water before they dry.
- Calcifications should be removed with a 5% sulfamic acid solution or with a commercial lime remover. The façade should be rinsed with clear water after cleaning.
- Panels discoloured by algal growth should be treated with an algicide without bleaching agents. This application should be allowed to take effect for several days. Afterwards, clean the panels using the 'normal dirt' procedure above.
- When rinsing down panels, use no more than 700 psi (50kh/cm<sup>2</sup>) of water pressure at a minimum of 3m distance from the face of the wall. Water pressure should be applied downward to avoid forcing water into joints.
- Use neutral detergent with a soft cloth or soft brush when removing dirty spots from a panel. When diluting the neutral detergent, follow the manufacturer's instructions and use the weakest solution possible.

For newly installed panels, wash down thoroughly in accordance with the Barestone cleaning instructions to remove debris collected on the surface of the panel during the transportation, installation and construction process.

**Inspection, Repair and Maintenance**

The durability of the Cemintel Barestone External range can be enhanced by periodic inspection and maintenance. Inspections should include examination of the coatings, flashings and seals. Any cracked or damaged finish or seals which would allow water ingress must be repaired immediately by resealing the affected area, or by removing the panel and replacing sealant. Any damaged flashings, sheets or sealant must be replaced as for new work.

Regularly inspect panel surfaces and follow wash-down procedures when required.

Ensure ventilation and drainage gaps between panels and flashings are clear of any debris.

It is recommended storing additional panels in case any panels are damaged in the future.

**Recoating**

To refresh the appearance of the panel, Cemintel Barestone External can be recoated with the Cemintel Edge Sealer. This will also enhance the water resistance of the panel and consequently minimise the absorption of environmental pollutants. Prior to recoating, the surface should be cleaned (refer above) and allowed to dry thoroughly (3 days in sunny conditions). Cemintel Edge Sealer can then be applied simply with a roller. Always test first in a non-conspicuous area.



COMPONENTS + ACCESSORIES











## 03

## COMPONENTS + ACCESSORIES

Note: Codes can change from time to time. Refer to the website for the current list of components prior to ordering.

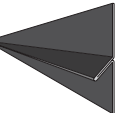
## Accessories





**Note: The length of batten fixings will need to be increased to ensure the same or greater embedment depth is obtained when additional layers or packers are added, such as a Rigid Air Barrier (RAB) and fire-rated linings. Nail fixing through multiple layers can be difficult and screw fixings are the preferred method of batten attachment.**

Product	Description	Size/Colour	Qty	Product Code
	<b>Cemintel Timber Fix Stainless Steel screws with EPDM seal</b> – for fixing cladding to battens. Screws have a corrosive coating applied and are colour matched to panels.	4.8 x 38mm Natural Silver	100/ pack	466225 466226
	<b>HDG Flat head nail</b> – for fixing batten to stud framing .	3.75mm dia x 75mm		Supplied by others
	<b>Paslode HDG or SS, screw shank or ring shank, dome head, 15°</b> – for fixing batten to stud framing.	3.15mm dia x 90mm		Supplied by others
	<b>Type 17 CSK Rib head, Phillips drive wood screw Class 3</b> – for fixing batten to stud framing.	8-10 x 57mm		Supplied by others
	<b>Battens</b> – 70 x 35mm H3 treated timber with a minimum stress level grade of MGP10 or equivalent. Battens reduce the number of structural noggings when off stud.	70 x 35mm		Supplied by others
	<b>EPDM Vertical Gasket band</b> used over all battens, at corners, and behind panel joints.	60mm wide x 50m 180mm wide x 25m	1 single roll	466220 470329
	<b>Angled Backing Strip</b> – a rolled aluminium section used at horizontal joints.	3040mm	1 each	132681
	<b>Sealant Sikaflex Sealant PRO Grey</b> – used to seal control joints, junctions etc. Other colours maybe used if available to this specification (supplied by Sika Australia).	310ml tube	1 each	11378
	<b>Backing Rod</b> – used to enable correct filling of joints with sealant.	10mm dia x 50m	1 each	11177
	<b>Cemintel Edge Sealer</b> – for sealing panel edges after on-site cutting.	200ml 2litre	1 each 1 each	100166 180928
	<b>Flashing &amp; Capping</b> – flashings are to be corrosion resistant to suit the project. They should be designed and installed in accordance with SAA-HB39 2015 and good building practice.	Custom		Supplied by others

## COMPONENTS + ACCESSORIES



Note: Codes can change from time to time. Refer to the website for the current list of components prior to ordering.

Product	Description	Size/Colour	Qty	Product Code
<b>CSR RIGID AIR BARRIER/WALL WRAPS</b>				
	<b>Cemintel Rigid Air Barrier*</b>	1200mm x 3000mm x 6mm	Pack of 30 sheets	170076
	<b>Enviroseal™ RW</b> Classification – Class 4 Vapour Permeable	1500mm x 25m	1 roll	141306
		1500mm x 30m	1 roll	192726
		1500mm x 50m	1 roll	120923
	<b>Enviroseal™ CW</b> Classification – Class 4 Vapour Permeable	1500mm x 50m	1 roll	118593
	<b>Enviroseal™ CW-IT</b> Classification – Class 4 Vapour Permeable	1500mm x 50m	2 rolls	153675
	<b>Thermoseal™ Wall Wrap</b> Classification – Non-permeable reflective Water Barrier	1350mm x 30m	1 roll	40483
		1350mm x 60m	1 roll	10576
	<b>Thermoseal™ Firespec</b> Classification – Non-permeable reflective Water Barrier	1500mm x 30m	1 roll	164674
	<b>Enviroseal Hightack Tape</b> – used to seal wall wrap at overlap joins, around openings, for repairs and at flashings. Black, single sided, aggressive adhesive tape with a high initial grab and flexible carrier.	60mm x 25m	1 roll	160950
	<b>Enviroseal SLS Flexi Tape</b> – used to tape corners of openings.	60mm x 5m	1 roll	124872
	<b>Enviroseal™ Double Sided Tape</b>	24mm x 50m	1 roll	124873
	<b>Reinforced Aluminium Foil Tape</b>	48mm x 50m	1 carton (24)	13054
	<b>Bradford Plasti-Grip Washers</b>	45 x 5mm	1 carton (1000)	136770
<b>INSULATION</b>				
	<b>Bradford Gold HP Wall Batts – R2.0 (75mm)</b>	1160mm x 420mm	12 pack	153643
		1160mm x 570mm	12 pack	153648
	<b>Bradford Gold HP Wall Batts – R2.5 (90mm)</b>	1160mm x 420mm	9 pack	181430
		1160mm x 570mm	9 pack	181471
	<b>Bradford Gold HP Wall Batts – R2.7 (90mm)</b>	1160mm x 420mm	5 pack	152191
		1160mm x 570mm	5 pack	152197
<b>TOOLS – When using Barestone Rivets the following tools must be used</b>				
	<b>Surround Drill Bit Ø 9.5mm</b> – for drilling accurate holes in the Barestone and Surround panels to accept the Cemintel Timber Fix screw. Fits standard 10mm drill chuck.		1 each	132673



A large, stylized graphic of the number '04' in white outline font, set against a dark green background. The '0' is a simple oval, and the '4' has a distinctive shape with a vertical stem and a horizontal base. The number is positioned in the lower half of the page.

# 04

SYSTEM DESIGN



## SYSTEM DESIGN



## System Design

Panels, battens, and structural framing are required to resist wind loads that are specific to the building site. It is recommended that the Architect / Building Designer assigns the responsibility for the facade design to the Project Engineer. Once wind loads have been determined, batten spans, fastener spacings, and sheet fixing details may be selected from the appropriate tables in this manual.

The recommendations in this guide are considered as good building practice and are not intended to be an exhaustive statement of all relevant data. Cemintel is not responsible for the performance of constructed walls and does not interpret or make judgements about NCC requirements for any project.

### Batten fixing

Tables are provided for the span, spacing, and fixing of timber battens to timber wall framing. The batten spans have been calculated in accordance with AS 1720.1: Timber Structures – design methods. Loads are based on AS 4055 with factored external pressure coefficient,  $k_1 C_{p'e} = -1.3$  &  $+0.7$ . The deflection of the battens as detailed in these tables is no more than span/250 when subjected to serviceability wind load of 68% of ultimate wind loads.

The minimum structural grade of the wall framing is to be F5, and the structural capacity of all support framing is to be confirmed by the project engineer. The battens may be fixed directly to studs or to appropriately designed horizontal members fixed between the studs. Additional timber members may also be required at ends of battens to ensure correct fastener end/edge distances are achieved.

## Design Tables – Maximum Timber Batten Span/Fastener Spacing

**TABLE 4.01** Maximum fastener spacing for fixing multiple span battens to timber framing – RESIDENTIAL (Class 1 and Class 10)

NOTE: This table is for the fasteners to fix 70 x 35mm F5 battens to timber framing. Fasteners are to be double screws or double nails at all batten connections to wall framing, and each batten must be fixed at three or more points. The minimum structural grade of the timber framing is MGP10. The structural capacity of all support locations to be confirmed by the project engineer.

Batten Spacing	Wind Classification	Double nail		Double screw	
		General Zone ①	Corner Zone ②	General Zone ①	Corner Zone ②
300	N1/N2	2300	1550	2300	1850
	N3/C1	1850	1000	2000	1550
	N4/C2	1250	650	1750	1150
	N5/C3	850	450	1400	750
	N6/C4	600	300	1050	550
400/450	N1/N2	1950	1050	2000	1600
	N3/C1	1250	650	1700	1100
	N4/C2	850	450	1400	750
	N5/C3	550	N/A	950	N/A
	N6/C4	400	N/A	700	N/A
600	N1/N2	1450	750	1800	1300
	N3/C1	900	500	1500	850
	N4/C2	600	300	1050	550

① GENERAL ZONES – Wall areas greater than 1200mm from an External Building Corner for Buildings satisfying the AS 4055 geometry limits.

② CORNER ZONES – Wall areas less than 1200mm from an External Building Corner for Buildings satisfying the AS 4055 geometry limits.

## 04

## SYSTEM DESIGN

**TABLE 4.02** Maximum fastener spacing for fixing single span battens to timber framing – RESIDENTIAL (Class 1 and Class 10)

NOTE: This table is for the fasteners to fix 70 x 35mm F5 battens to timber framing. Fasteners are to be double screw or double nail at all batten connections to the wall framing.

Batten Spacing (mm)	Wind Classification	Double Nail or Screw	
		General Zone ①	Corner Zone ②
300	N1/N2	1850	1500
	N3/C1	1600	1300
	N4/C2	1400	1150
	N5/C3	1250	1000
	N6/C4	1100	850
400/450	N1/N2	1600	1300
	N3/C1	1400	1150
	C2	1200	1000
	N5/C3	1050	N/A
	N6/C4	950	N/A
600	N1/N2	1450	1200
	N3/C1	1250	1000
	N4/C2	1100	850

① GENERAL ZONES – Wall areas greater than 1200mm from an External Building Corner for Buildings satisfying the AS 4055 geometry limits.

② CORNER ZONES – Wall areas less than 1200mm from an External Building Corner for Buildings satisfying the AS 4055 geometry limits.

**Design Tables – Maximum Cladding Span and Fastener Spacing****TABLE 4.03** Panel spans and connections – General zones – RESIDENTIAL (Class 1 and Class 10)

Note: This table is for the spans of Barestone and Surround panels fixed to timber battens with Timber Fix Stainless Steel screws.

Wind Classification	Panel fixed to three or more battens		Maximum fastener spacing
	Panel fixed to two battens	battens	
N1/N2	600	600	600
N3/C1	600	600	600
N4/C2	450	600	600
N5/C3	450	600	600
N6/C4	450	400	500

**TABLE 4.04** Panel spans and connections – Corner zones – RESIDENTIAL (Class 1 and Class 10)

Note: This table is for the spans of Barestone and Surround panels fixed to timber battens with Timber Fix Stainless Steel screws.

Wind Classification	Panel fixed to three or more battens		Maximum fastener spacing
	Panel fixed to two battens	battens	
N1/N2	600	600	600
N3/C1	450	600	600
N4/C2	450	600	550
N5/C3	300 <sup>3</sup>	300 <sup>3</sup>	450
N6/C4	300	300 <sup>3</sup>	400

(3) Limited by batten spacing

## SYSTEM DESIGN



FIGURE 4.01 Battens Off-Stud

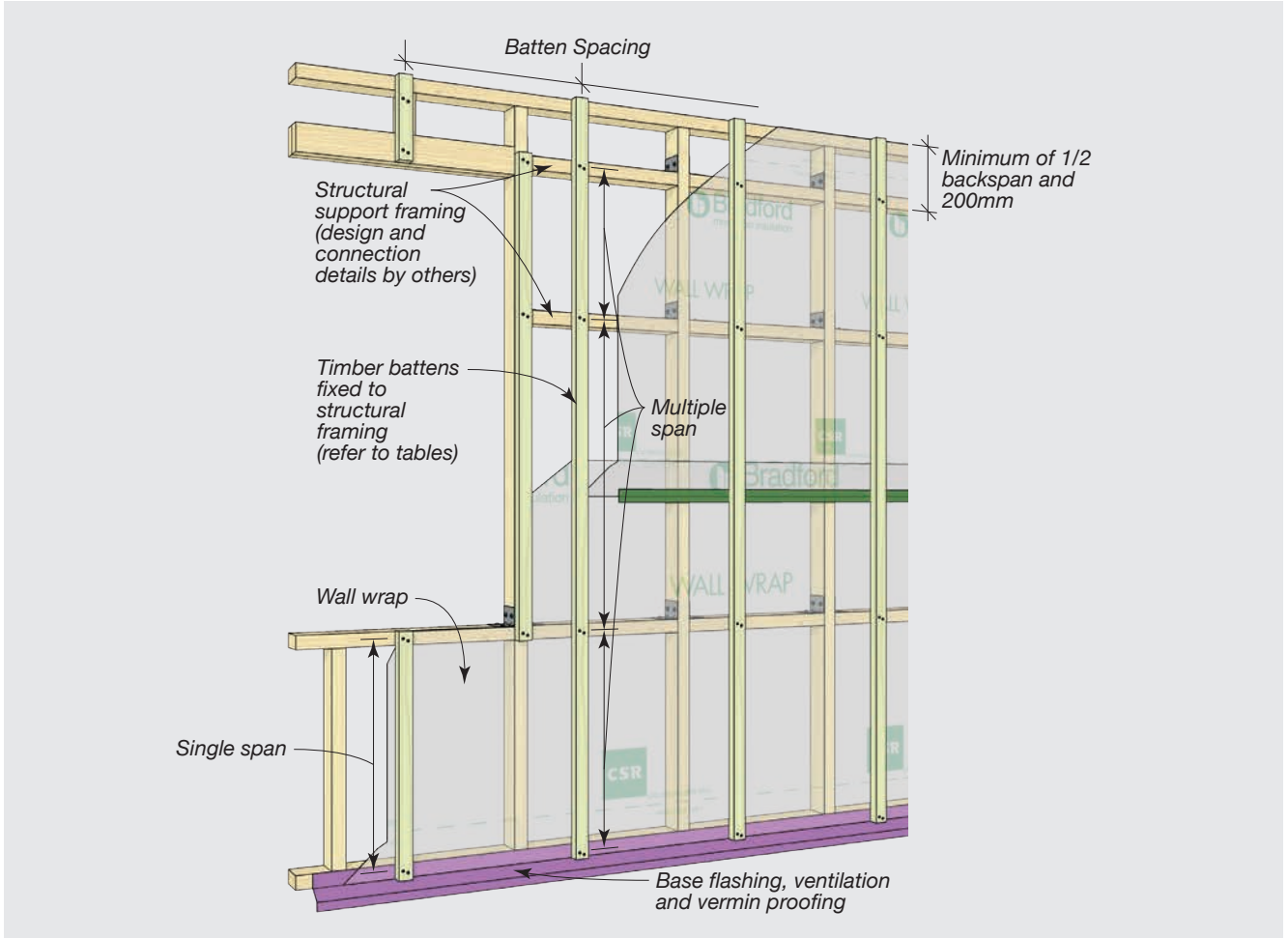

# 05

INSTALLATION

## INSTALLATION

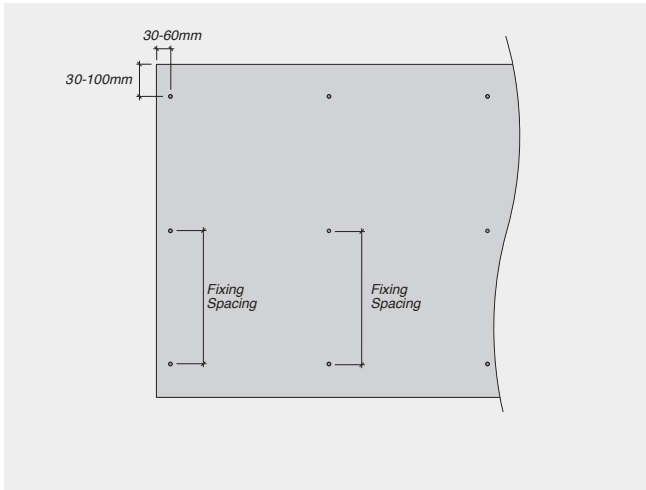
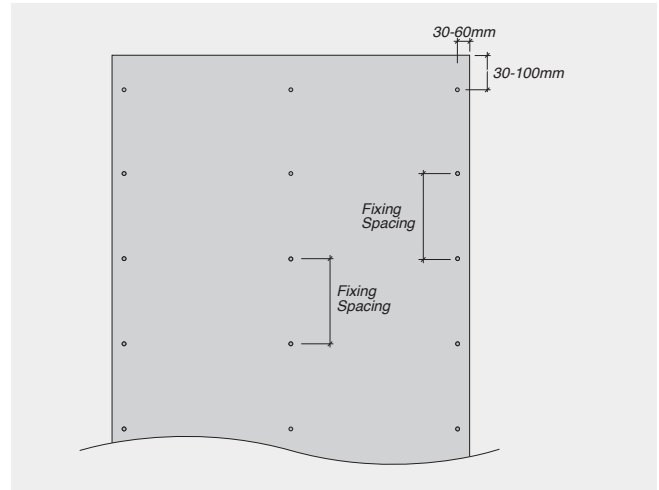
**FIGURE 5.01** Horizontal Sheet Fixing

**FIGURE 5.02** Vertical Sheet Fixing

## Installation Procedure

**Step 1** – Install air barrier as per Cemintel Rigid Air Barrier – Design & Installation Guide and Cemintel Facades and Cladding – Design Guide.

**Step 2** – Install windows.

**Step 3** – Fix base flashing to base of wall over air barrier, taping top edge of flashing to air barrier.

**Step 4** – Fix timber battens, using packers where necessary to ensure accurate alignment. Fix battens vertically to wall framing as per Tables 4.01, 4.02 and 4.03.

**Step 5** – Prepare panels. Cut panels as required. A minimum 200mm panel width is recommended to maintain adequate fastener spacing and edge distances. Run a fine sandpaper block along the edge of the cut panel (taking care not to scratch the panel surface). Seal cut edges with Cemintel Edge Sealer to protect against moisture entering the panels.

**Step 6** – Drill panel holes with Cemintel drill bit. This should be done prior to lifting panels into place and can be done off site. DO NOT use hammer/impact setting whilst drilling, and fully support the back of the sheet to avoid blowout of the panel. DO NOT use countersink screws, only the specified Cemintel Timber Fix Stainless Steel screws with EPDM seal so as not to void warranty.

**Step 7** – Install centrally EPDM Vertical Gasket band to all battens for the full extent of panels. Use only single strips of EPDM Vertical Gasket band and do not double over. Fix with nails, staples or screws at edge of gasket, as required to hold in place until panels are installed. Use a single length of gasket for each framing member.

**Step 8** – Fix panels from top to bottom. Hold or clamp the panel into position. Insert the EPDM seal with attached screw into the pre-drilled hole and tighten with screw gun, ensuring screws fully embed into the batten. Insert the horizontal angled backing strip prior to complete tightening of perimeter screws.

Joint widths – Panels are generally installed with a nominal 8-10mm wide horizontal and vertical expressed joint. Joints up to 20mm can be formed provided additional care is taken during installation to ensure that screws have sufficient edge distance into the battens.

**Fitting Tip:** Fit panels from top to bottom. This allows:

- simple alignment of panels, using a batten beneath the panel as support
- the scaffolding can be dismantled at the same time as the façade is fitted

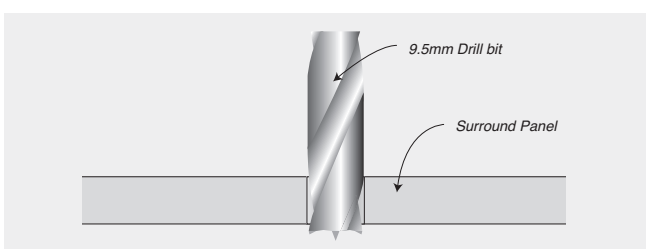
**FIGURE 5.03** Drilling Panels



CONSTRUCTION DETAILS

## CONSTRUCTION DETAILS



## Drawings Index

SECTION	DESCRIPTION	FIGURE REFERENCE	PAGE NUMBER
<b>Fixing Details</b>	Panel Fixing At Intermediate Batten	6.01	23
	Panel Fixing At Vertical Joint	6.02	24
	Panel Fixing At Control Joint	6.03	24
<b>Corner Details</b>	Internal Corner Detail	6.04	25
	External Corner Detail	6.05	25
<b>Off-Stud Framing &amp; Base Details</b>	Off-Stud Framing Detail	6.06	25
	Base Detail With Drainage	6.07	25
<b>Eaves/Soffit Details</b>	Eaves With Timber Trim	6.08	26
	Eaves With Territory Trim	6.09	26
	Soffit Detail	6.10	26
<b>Horizontal Junctions</b>	Horizontal Exposed Joint	6.11	26
	Inter-Storey Junction Detail	6.12	27
<b>Roof/Parapet Details</b>	Raked Roof Intersection	6.13	27
	Parapet Detail	6.14	27
	Skillion Roof Detail	6.15	28
<b>Window/Door Details</b>	Typical Window Head, Jamb and Sill	6.16	28
<b>Meter Box Details</b>	Meter Box	6.17	29

FIGURE 6.01 Panel Fixing at Intermediate Batten

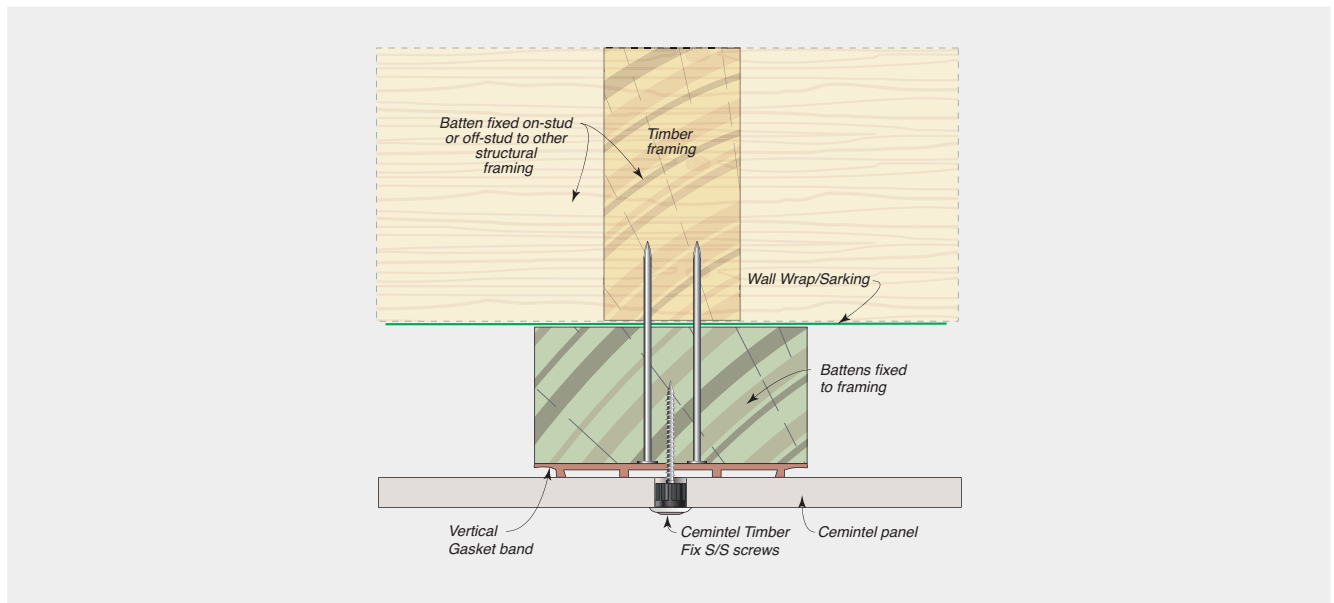



CONSTRUCTION DETAILS

FIGURE 6.02 Panel Fixing At Vertical Joint

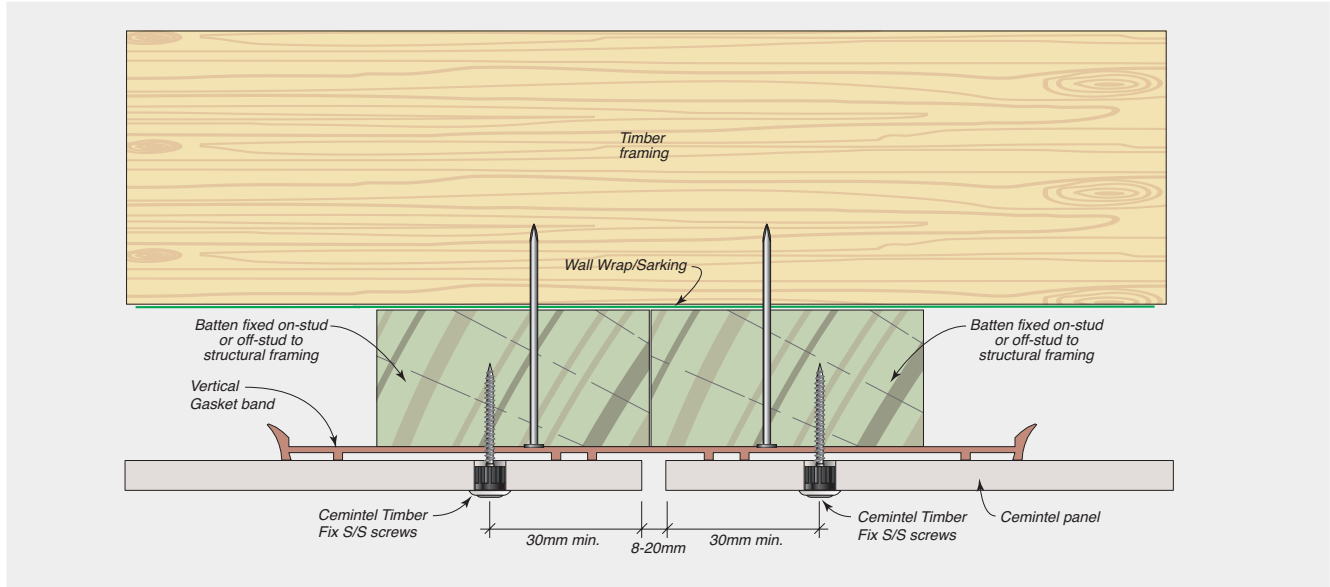
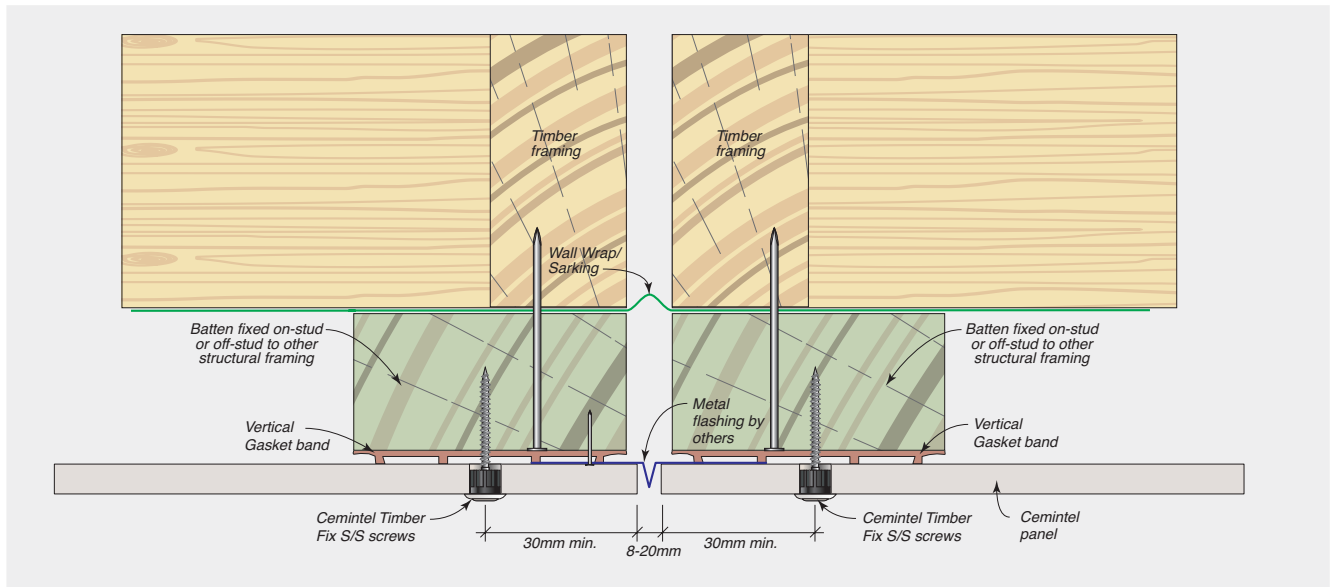

FIGURE 6.03 Panel Fixing At Control Joint





CONSTRUCTION DETAILS



FIGURE 6.04 Internal Corner Detail

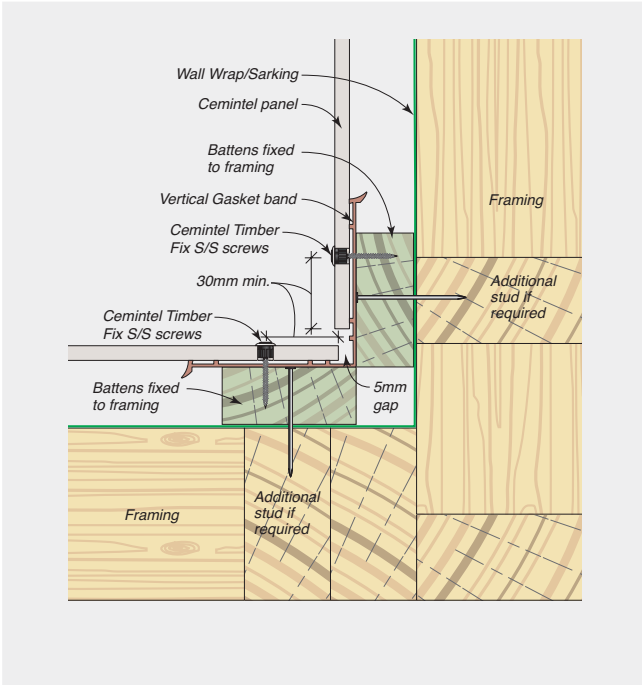

FIGURE 6.05 External Corner Detail

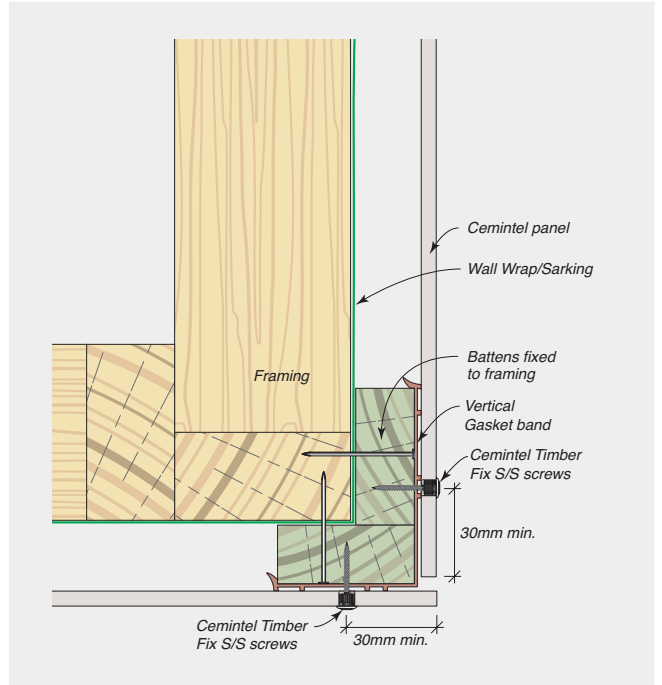

FIGURE 6.06 Off-Stud Framing Detail

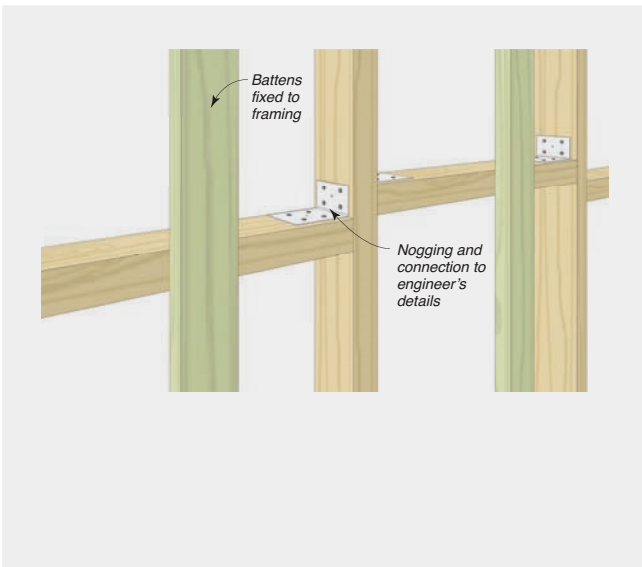
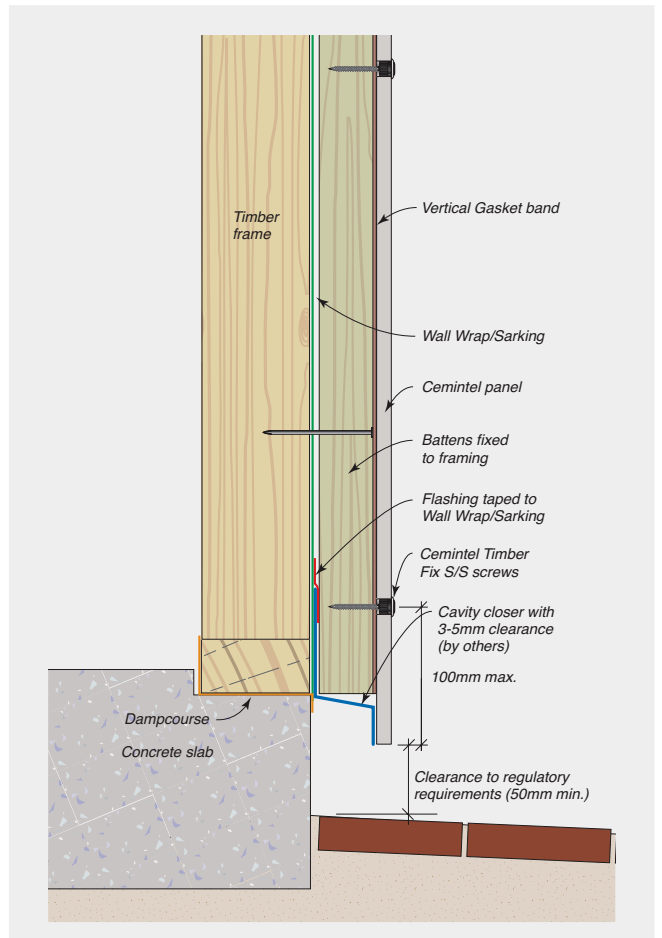

FIGURE 6.07 Base Detail With Drainage





# CONSTRUCTION DETAILS

**FIGURE 6.08** Eaves With Timber Trim

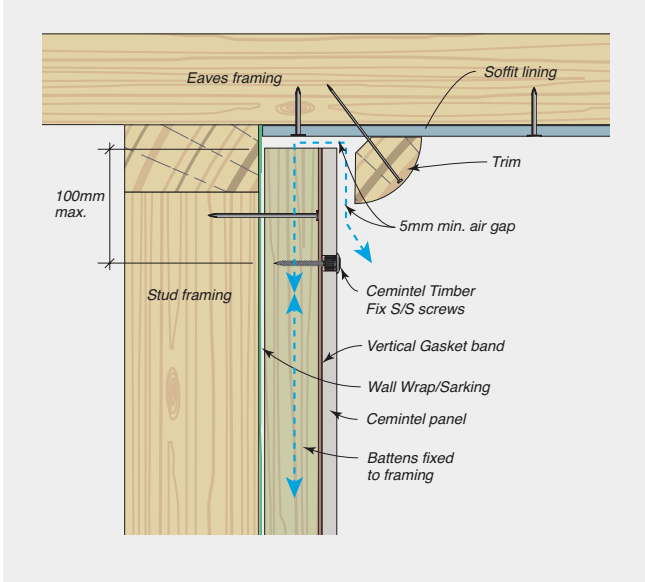

**FIGURE 6.09** Eaves With Territory Trim

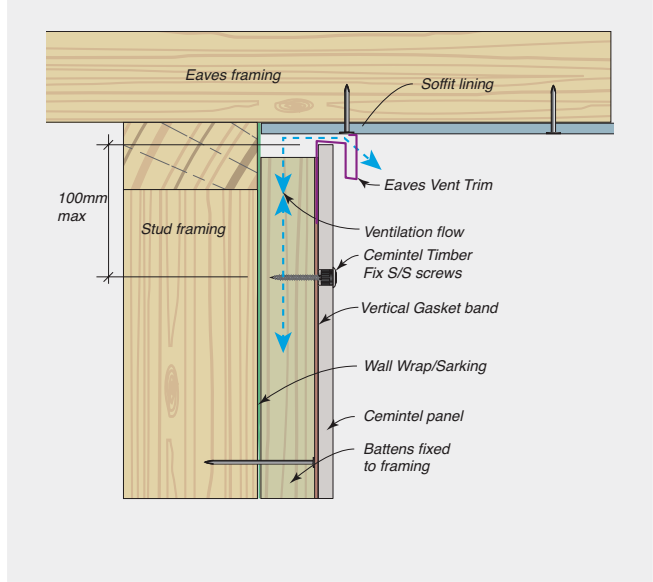

**FIGURE 6.10** Soffit Detail

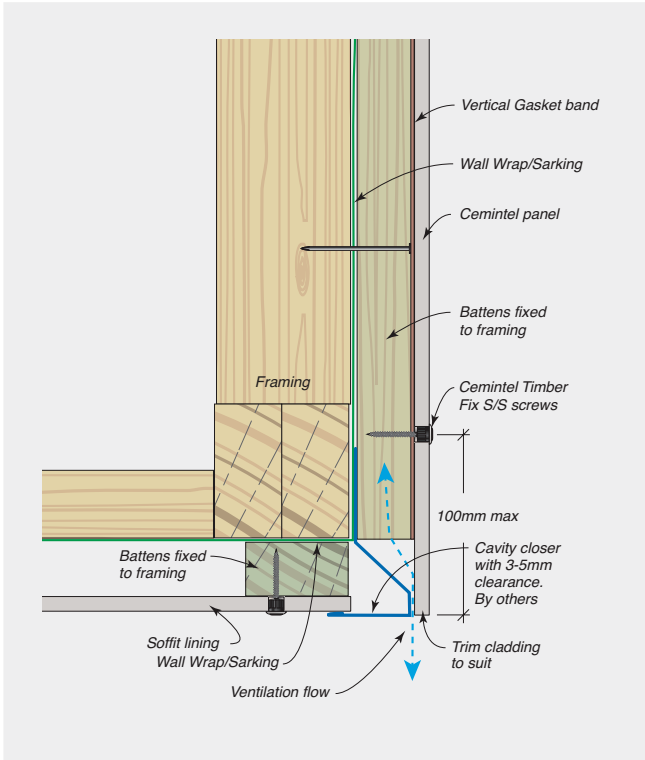

**FIGURE 6.11** Horizontal Exposed Joint

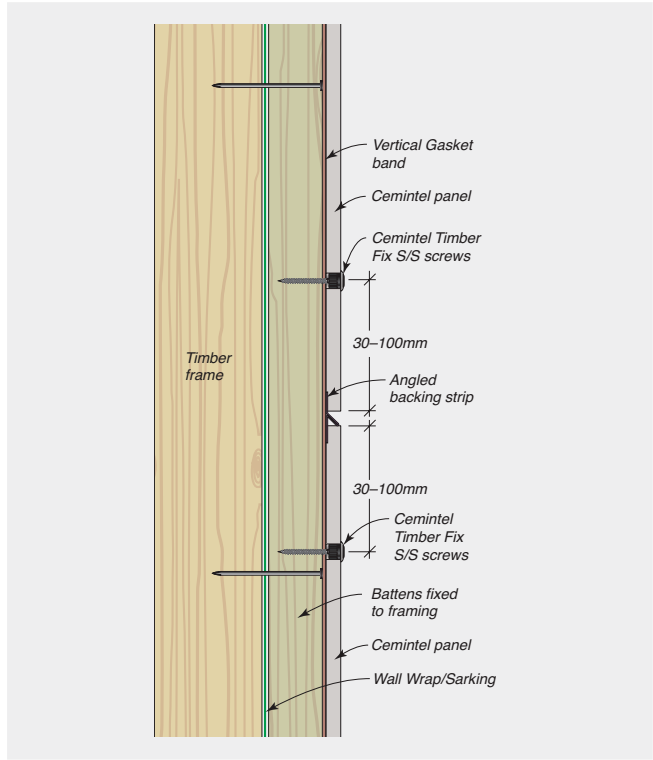

CONSTRUCTION DETAILS



FIGURE 6.12 Inter-Storey Junction Detail

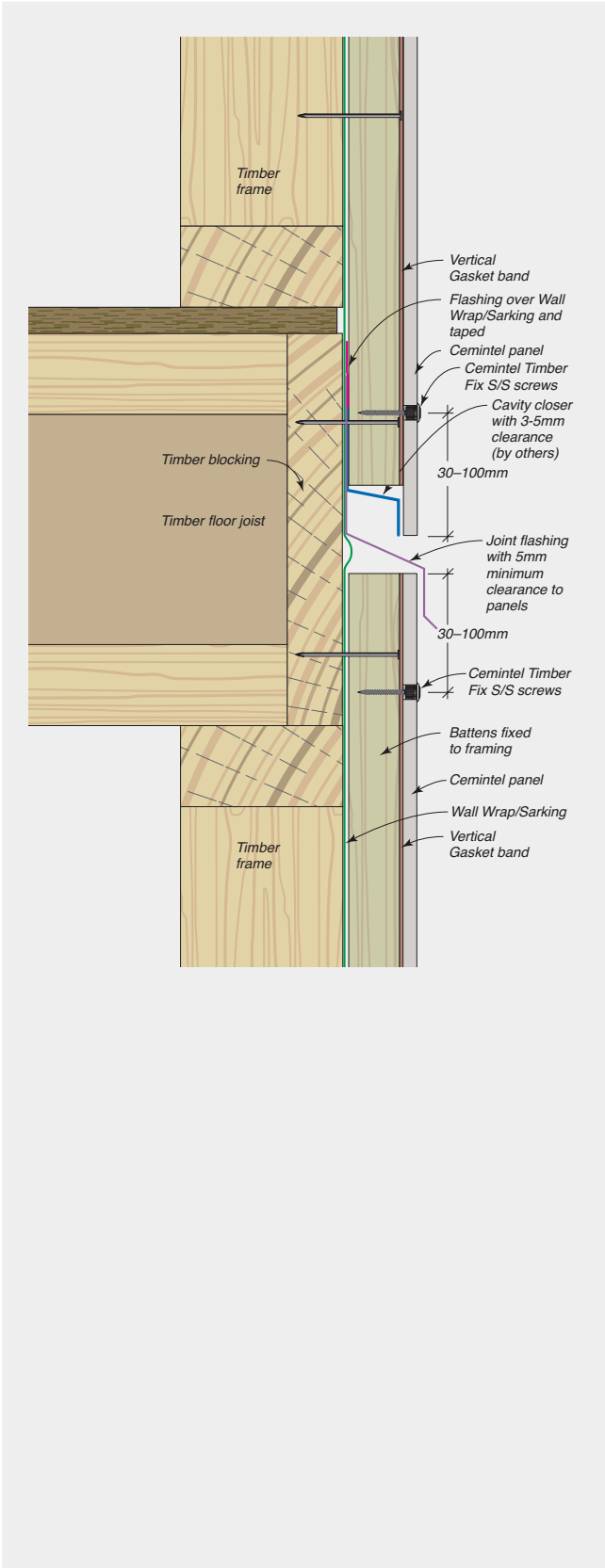

FIGURE 6.13 Raked Roof Intersection

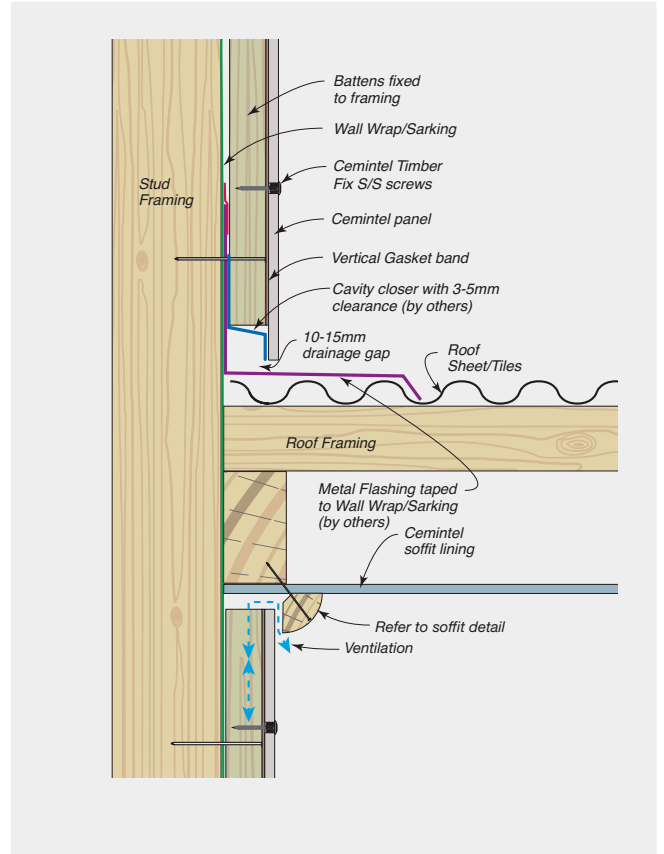
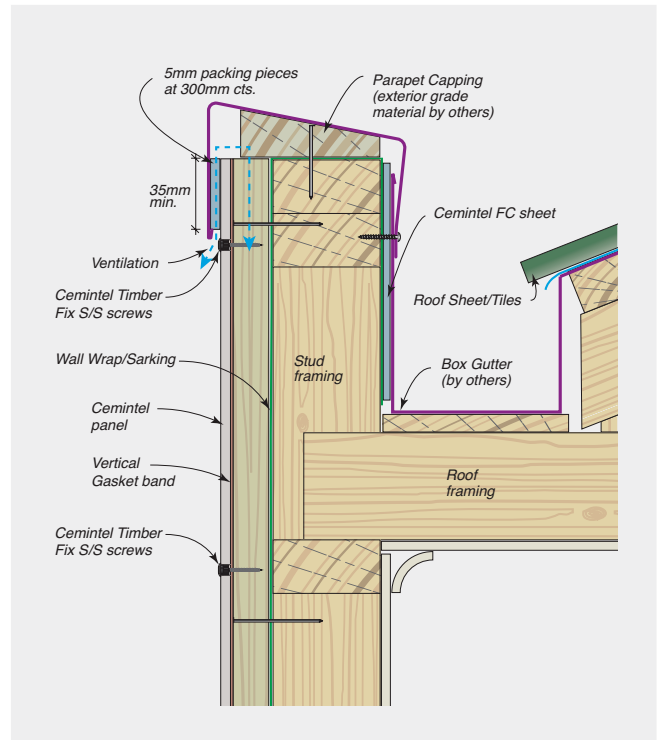

FIGURE 6.14 Parapet Detail





CONSTRUCTION DETAILS

FIGURE 6.15 Skillion Roof Detail

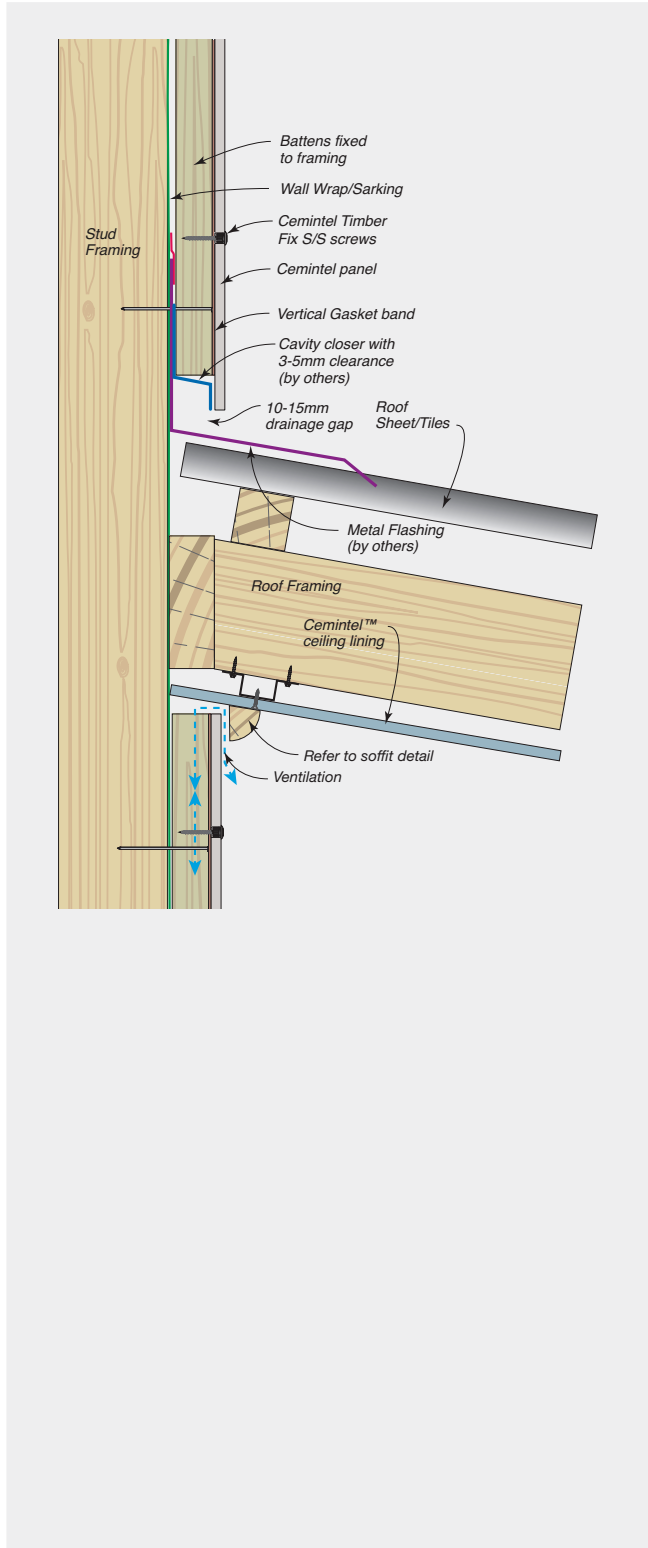
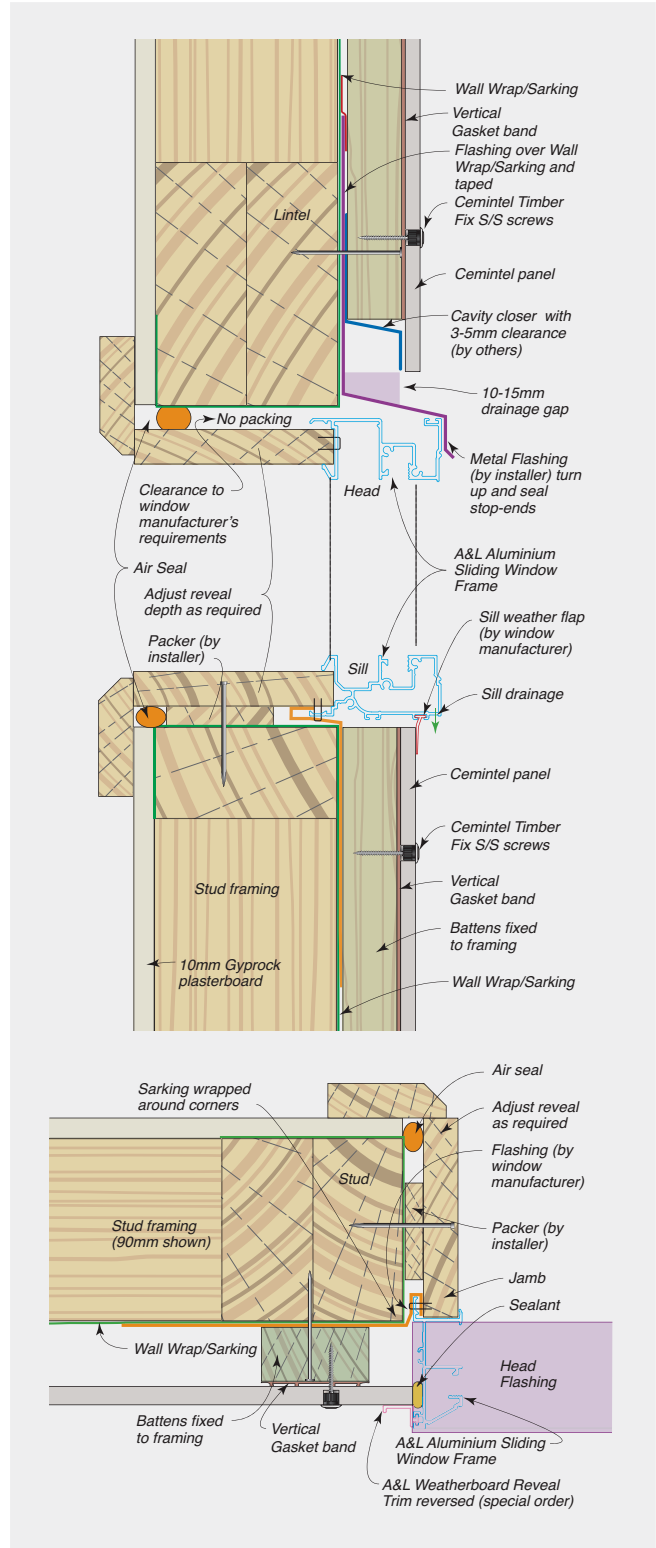

FIGURE 6.16 Typical Window Head, Jamb and Sill



CONSTRUCTION DETAILS



FIGURE 6.17 Meter Box

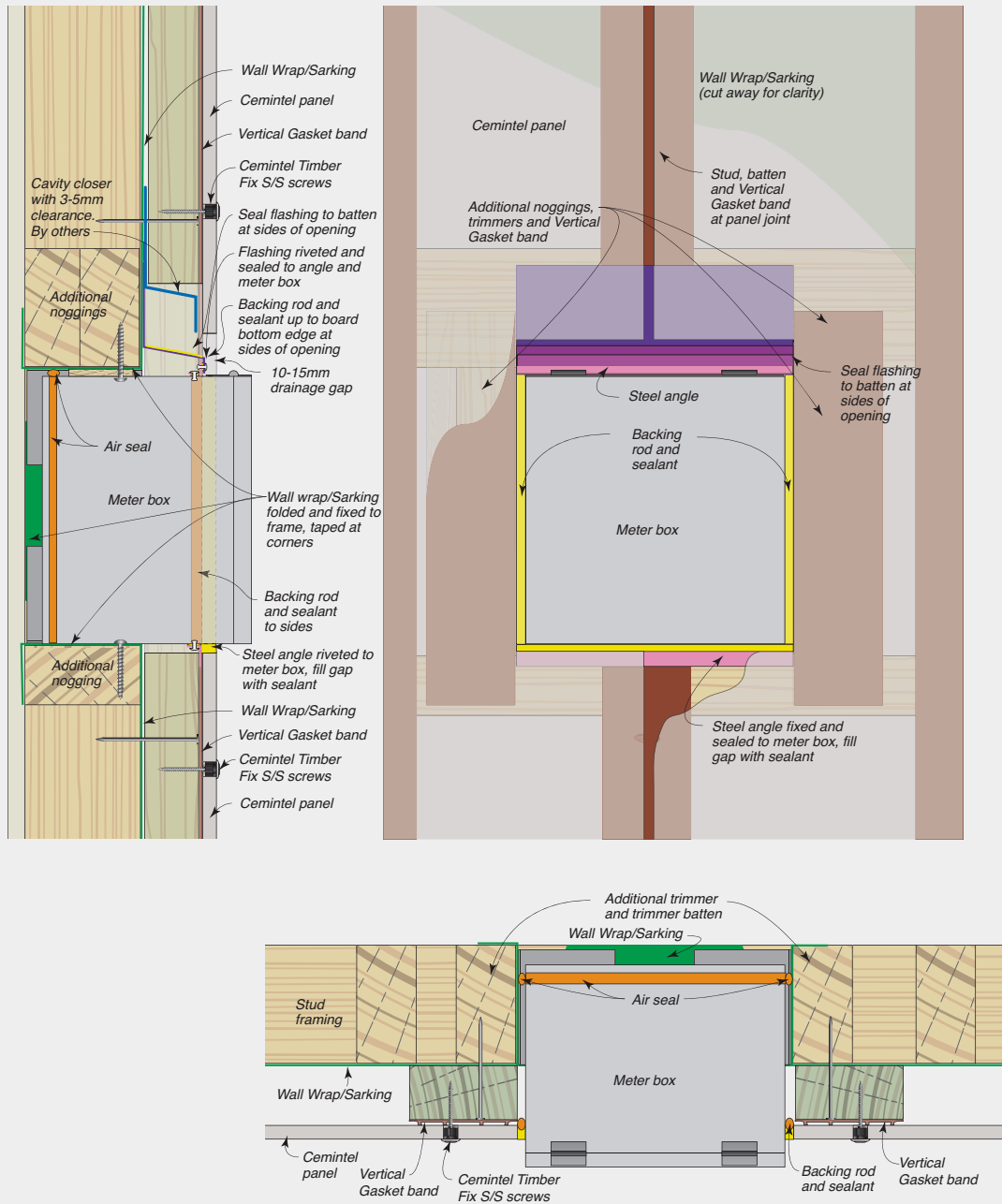

# 07

SAFETY, HANDLING, GENERAL CARE  
+ WARRANTY

## SAFETY, HANDLING, GENERAL CARE + WARRANTY

07

### Health, Safety and Personal Protection Equipment (PPE)

#### Fibre Cement contain silicas that are harmful if inhaled. Protective clothing and breathing equipment should be worn when cutting products.

When cutting, drilling or grinding fibre cement panels using power tools, always ensure the work area is properly ventilated.

An approved dust mask (AS/NZS 1715 and AS/NZS 1716) and safety glasses (AS/NZS 1337) must be worn. Cemintel recommends that hearing protection also be worn.

Safety Data Sheet information is available at [www.cemintel.com.au](http://www.cemintel.com.au)

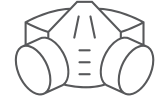

#### Managing Respirable Crystalline Silica Dust

Crystalline Silica is everywhere. It is found naturally in stone, rocks, sand, gravel and clay. Sand is one of the raw materials in Fibre Cement. Respirable Crystalline Silica dust is the fine dust that's created when you use power tools to cut, drill, grind, chip or sand materials and products that contain crystalline

silica. This dust is of concern due to its size as it gets caught deep in your lungs and can cause long term damage.

IF YOU USE THE CORRECT SAFETY EQUIPMENT AND PPE, FIBRE CEMENT IS SAFE TO USE.

### Cemintel Safety Requirements

1 - Cut Outdoors*	The ventilation outdoors is greater than that indoors, and therefore should reduce exposure.
2 - Use On-Tool Dust Extraction	Use on-tool dust extraction when using power tools to drill and cut Fibre Cement, with a vacuum that contains a HEPA M Class filter.
3 - Correct Saw and Blade	Use a plunge saw with a specifically designed Fibre Cement blade
4 - Don't Sweep, Vacuum instead	When completing your work vacuum with a HEPA M Class filter, rather than a broom as sweeping creates more dust.
5 - Use Correct Respirator	Use a half face P1 or P2 respirator. It is essential that the respirators are Fit Tested and workers are cleanly shaven to obtain a good seal

\* Even though not recommended, indoor cutting can be completed when using an onsite cutting room with exhaust ventilation and a M class filter at a minimum, on-tool dust extraction with a vacuum with a HEPA M Class filter, a Full Face P2 respirator and conducting local occupational and static air monitoring to validate effectiveness of control measures.

### Safety, Handling, and Maintenance

#### Storage

All Cemintel panels must be stacked flat, clear of the ground and supported at 300mm maximum centres on a level platform. Panels must be kept dry, preferably stored inside the building. Panels must be dry prior to fixing, hence if it is necessary to store outside, the product must be protected from the weather.

#### Handling

Prefinished products and must be treated with care during handling to avoid damage to edges, ends and prefinished surface. Panels should be carried horizontally on edge by at least two people.

Consideration should be given to planning the order of other trades that might stain or damage the panels.

Any splashings of mud, cement, mortar and the like should be removed immediately.

#### Cutting

Panels should be fully supported and cut from the back using a power saw. Cemintel recommends using the Makita Plunge Cut Saw with guide rail and appropriate blade, together with the appropriate dust extraction system. All exposed cut edges **MUST BE SEALED WITH CEMINTEL EDGE SEALER TO PREVENT MOISTURE ABSORPTION.**

#### Mitres

It is not recommended to mitre panel edges as this can cause delamination of the face.

#### Penetrations

Penetrations in panels may be cut or drilled prior to installation. Cut from the back or drill from the front. Mask, prime and fill gaps with sealant in accordance with recommended methods and products.

### Warranty

Cemintel Barestone External and Surround External panels have a product warranty of 10 years. The full product warranty is available for download at [cemintel.com.au](http://cemintel.com.au)



---

## Our Offices

### Sydney

376 Victoria Street  
Wetherill Park NSW 2164

### Adelaide

Lot 100 Sharp Court  
Mawson Lakes SA 5095

### Darwin

Cnr Stuart Highway  
& Angliss Street  
Berrimah NT 0828

### Melbourne

277 Whitehall Street  
Yarraville VIC 3013

### Perth

19 Sheffield Road  
Welshpool WA 6106

### Brisbane

768 Boundary Road  
Coopers Plains QLD 4108

### Hobart

11 Farley Street  
Derwent Park TAS 7009

**cemintel.com.au**  
1300 236 468

For Design and Technical Support:  
**DesignLINK** – 1800 621 117

Cemintel is a trading entity of CSR Building Products Limited (ACN 008 631 356).

The products referred to in this document have been manufactured by or on behalf of CSR Building Products Limited ("CSR") to comply with the National Construction Code of Australia (NCC) and any relevant Australian Standards. While any design or usage guidelines set out in this document have been prepared in good faith by CSR, they are of a general nature only and are intended to be used in conjunction with project specific design and engineering advice. It is the responsibility of the customer to ensure that CSR's products are suitable for their chosen application, including in respect of project-specific matters such as, but not limited to structural adequacy, acoustic, fire resistance/combustibility, thermal, and weatherproofing requirements. All information relating to design/installation/application of these products is offered without warranty and no responsibility can be accepted by CSR for errors and omissions, or for any use of the relevant products not in accordance with CSR's technical literature or any other relevant industry standards. For current technical and warranty documentation relating to Cemintel's products, visit Cemintel's website at [www.cemintel.com.au](http://www.cemintel.com.au).

09/2024