

CEMINTEL®

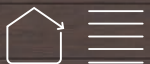

External Wall (EW) Classification to AS 5113

TERRITORY™ SERIES
External Horizontal Installation

INTRODUCTION

TABLE OF CONTENTS

01 INTRODUCTION	2		
Introduction	2		
02 PRODUCT OVERVIEW	3		
Panel Information	4		
Product Specifications	4		
Colour Palette	5		
AS 5113 EW Classification	6		
03 SYSTEM OVERVIEW	7		
Applications	9		
Benefits of the Cemintel Territory System	9		
Product Specifications/System Solutions	9		
04 DESIGN + AESTHETIC CONSIDERATIONS	10		
General	11		
Control Joints	11		
Coverage	12		
Window & Door Openings	12		
Eaves Junction	12		
Corners	12		
Face Fixings	12		
Structural	13		
Moisture Management	13		
Climate Zones for Thermal Design	17		
Energy Efficiency & Thermal Design	18		
Fire Performance	19		
Extreme Climate Conditions	20		
Corrosivity Categories	21		
Other Design Considerations	22		
Wash Down Process	22		
		Inspection, Repair and Maintenance	22
		05 COMPONENTS + ACCESSORIES	23
		06 SYSTEM ENGINEERING	28
		Design, Detailing and Performance	
		Responsibilities	29
		Span Tables / Wind Loads	30
		Masonry Substrates	33
		Cemintel Rigid Air Barrier Design	34
		Cemintel Soft Air Barrier Design	34
		07 INSTALLATION	35
		Checklist – Prior to Installation	36
		Installation Set-Out	
		– Timber Framing	37
		– Steel Framing	39
		– Masonry	41
		Installation for Timber and Steel Framing	44
		Installation of Wall Wrap	44
		Installation of Territory Panels	46
		Installation for Masonry	48
		Installation of Cemintel Rigid Air Barrier™	49
		Installation of Soft Air Barriers	51
		08 CONSTRUCTION DRAWINGS + DETAILS	53
		09 SAFETY, HANDLING, GENERAL CARE + WARRANTY	83
		Health, Safety and PPE	84
		Handling & General Care	84
		Warranty	84

Introduction

Cemintel Territory is a prefinished cladding system that simulates materials such as timber, concrete, metal and brick.

Territory cladding is a 16mm thick cement bonded fibrous wood particle panel that is pressed with surface textures and finished with a high quality paint and UV coating. Panels are 3030mm in length, with an effective cover width of 455mm, and connect seamlessly into each other via a tongue and groove profile.

Territory cladding panels are supported by a proprietary concealed fixing system that enables the panels to be installed on masonry, timber and steel frames, either horizontally or vertically, externally or internally, on both residential and commercial buildings.

This Design and Installation Guide recommends good building practice methodology and has been prepared as a general guide of design considerations, system engineering information

and installation procedures for common external horizontal applications.

It assumes that the user has an intermediate knowledge level of building design and construction. In no way does it replace the services of the building professionals required to design projects, nor is it an exhaustive guide of all possible scenarios. It is the responsibility of the architect, designer and various engineering parties to ensure that the details in this Design and Installation Guide are appropriate for the intended application.

This guide refers to **external horizontal installations** only as components differ depending on the installation.

Refer to the 'Design and Installation Guide for Cemintel® Territory External Vertical Installation' or the 'Design and Installation Guide for Cemintel Territory Internal Installation' for instructions regarding these applications.



PRODUCT OVERVIEW

Panel Information

Cemintel Territory cladding is a 16mm thick cement-bonded fibrous wood particle panel that's pressed with surface textures and finished with a high-quality paint and UV coating. The panels are 3030mm in length with an effective cover width of 455mm and connect seamlessly into each other via a tongue and groove profile.

The Territory cladding panels are supported by a proprietary concealed fixing system that enables the panels to be installed either horizontally or vertically, externally or internally, on both residential and commercial buildings.

Panels have a special NichiGuard® self cleaning coating* applied during the manufacturing process to Japanese standards. Panels include Platinum Coating technology to protect against UV damage and colour fade.

There is a range of coloured accessories including pre-formed external corner profiles, joint sealants and touch up paint kits to speed installation and enhance the project finish and appearance.

An alternative aluminium corner can also be used for a more contemporary aesthetic.

Cemintel Territory cladding conforms to the requirements of BS EN 12467:2012 – Fibre-cement flat sheets - Product specification and test methods, Category A, Class 2. The BS EN 12467 bending strength testing demonstrates the Cemintel Territory cladding conforms to the requirements of AS/NZS 2908.2 – Cellulose-cement products, Part: 2 – Flat sheets, Category 3, Type A.

*Note: not all panels have NichiGuard self cleaning coating – check Technical Data Sheet.

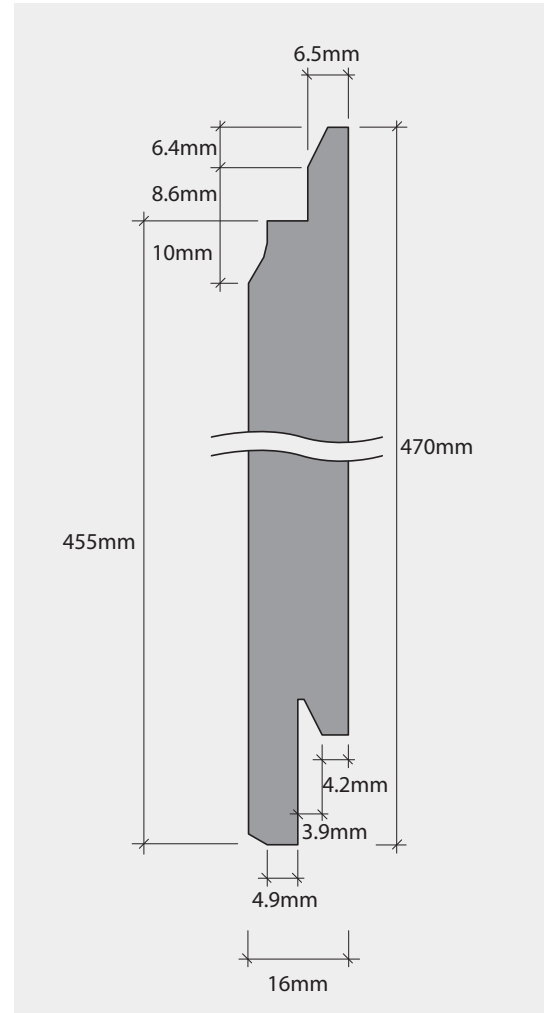

Product Specifications

Property	Specification	Tolerance	Reference
Panel Width	470mm (overall width) 455mm (effective coverage)	+1.0mm / -1.0mm	JIS A 5422
Panel Length	3030mm	+1.0mm / -1.0mm	JIS A 5422
Panel Thickness	16mm	+1.2mm / -1.2mm	JIS A 5422
Panel Weight (EMC)	24.6kg to 30kg per panel. Weight varies depending on finish. (Note: 2 panels per pack)		

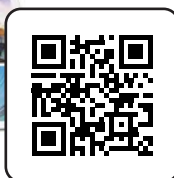

← **Download Brochure**

PRODUCT OVERVIEW



Colour Palette

WOODLANDS

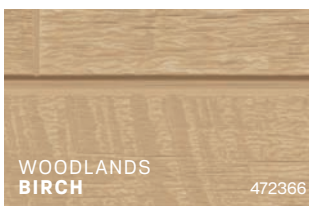
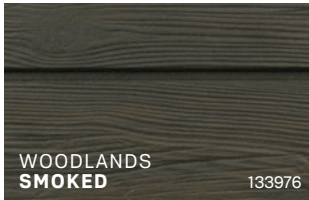

RIDGE



QUARRY

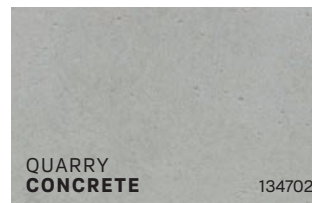

BRICK

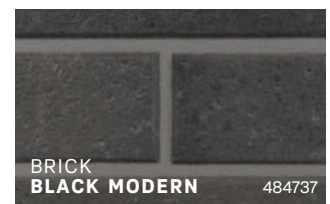

As Territory is a prefinished product, these images may vary from the actual product in regard to colour and surface finish. Panels should be inspected by the owner prior to installation to ensure they meet aesthetic requirements.

AS 5113 EW (External Wall) Classification

Cemintel's Territory is the first fibre cement product in Australia to achieve the AS 5113 EW (External Wall) classification.

The images below illustrate the AS 5113 test for Territory. Territory is a unique product in that it satisfies the DTS requirements of the NCC, and additionally has passed the AS 5113 test with an EW (External Wall) classification.

Use this link to view the test: www.youtube.com/watch?v=nR8ZZQSLeo



Intensive flames and heat during fire test.



Territory panels intact following removal of fire crib.

A large, stylized number '033' is rendered in a light beige color, serving as a background for the title. The '0' is a simple oval, while the '3's are more complex, with a curved top and a small loop at the bottom.

SYSTEM OVERVIEW

03

SYSTEM OVERVIEW

Cemintel Territory panels are installed with a unique clip system – providing a ventilated cavity.

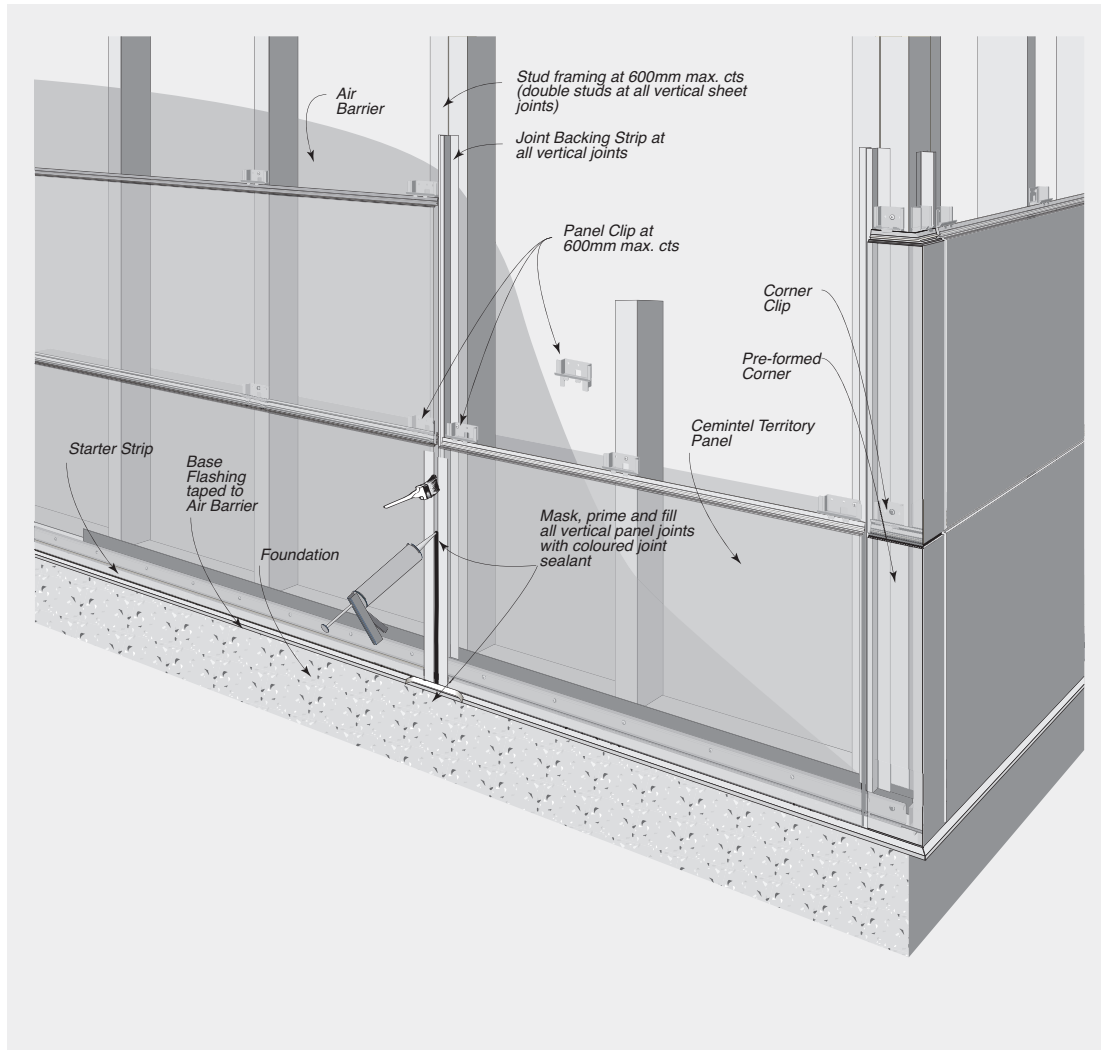

Cemintel Territory is installed largely as a concealed fixing system, using clips that are fixed to the frame. Territory panel clips, together with spacer strips, base starter strips and head vents/eaves trims, create a 15mm cavity behind the Territory panels which allow air flow, ventilation and drainage. This prevents moisture build up and reduces the risk of moisture penetration, allowing the building shell to dry out, creating a healthier, more breathable building.

Aluminium corners can be used as an alternative to the pre-formed corners shown above.



SYSTEM OVERVIEW



Applications

Cemintel Territory is suitable for all building classes, however, site environmental factors such as wind pressures and corrosivity zones must be considered to determine its suitability for a particular application. CodeMark Certificate of Conformity No. GM-CM 30048 has been obtained for installation to timber, steel and masonry frames. The Certificate confirms compliance with NCC clauses relating to structure, weather resistance, bushfire construction, thermal resistance and non-combustibility, and also confirms the achievement of EW (External Wall) classification to AS 5113.

When installed horizontally, the panels and system have been tested to withstand non-cyclonic wind pressures up to 6kPa and cyclonic regions up to 4.5kPa (with long clips).



Benefits of the Cemintel Territory System

- CodeMark Certified CM30048.
- Tested in accordance with AS 5113 and assessed as achieving the classification EW for an external wall performance that can avoid the spread of fire.
- Fire – fibre cement sheets can be used where non-combustible material is required under the NCC provisions.
- Suitable for Bushfire Attack Level up to 40 (BAL-40) when constructed in accordance with AS 3959.
- Group Number 1 for internal lining in accordance with AS 5637.1/ISO 9705.
- Prefinished and available in a variety of colours and textures.
- Minimal ongoing maintenance and long lasting protection against UV damage and colour fade.
- Proprietary concealed fixing system provides a ventilated cavity for effective moisture management.
- Compatible with other Cemintel prefinished cladding systems including Surround and Barestone.
- Integrates easily into mixed façade systems that use concrete, brick, or AAC such as Hebel.
- Complete cladding system including preformed corners and coloured sealants.

Product Specifications/System Solutions

Property	Specification	Reference
Façade Spread of Fire	EW classification.	AS 5113
Combustibility	Panels are suitable for use in applications where non-combustible materials are specified by the Deemed to Satisfy Provisions of the NCC.	NCC 2022 C2D10 [2019: C1.9]
Fire Resistance Limits (FRLs)	Up to 90/90/90 when used in a system with Gyprock fire grade plasterboard.	Refer to Gyprock® The Red Book™
Bushfire Construction	Suitable for use on buildings located in a designated Bushfire-Prone Area subject to a Bushfire Attack Level up to and including BAL-40 when constructed in accordance with AS3959:2018 (and subject to state and territory variations) to meet the DTS requirements.	AS 3959
Weatherproofing	Suitable for serviceability wind pressures up to +/-3.5kPa based on rigid air barrier being used and ultimate wind pressures up to +/-2.5kPa based on Enviroseal CW-IT soft air barrier being used. (Rigid air barrier recommended for ultimate wind pressures above 2.5kPa.) Suitable for serviceability wind pressures up to +/-1.5kPa based on a sarking/wall wrap being used.	AS/NZS 4284
Wind resistance	Suitable for ultimate wind pressures of +/-6kPa based on cladding secured with clips and face screws. (Rigid air barrier is recommended for ultimate wind pressures above 2.5kPa.)	AS/NZS 1170.2
Cyclonic Conditions	Passed at 4.5kPa (using long clip). Passed at 2.72kPa (using short clip).	AS 4040.3

A technical Data Sheet can be downloaded from cemintel.com.au

A large, stylized number '04' is rendered in white with a thick outline, set against a dark blue background. The '0' is a simple circle, and the '4' is composed of geometric shapes. The number is positioned in the lower half of the page, with the text 'DESIGN + AESTHETIC CONSIDERATIONS' overlaid on it.

04

DESIGN + AESTHETIC
CONSIDERATIONS

DESIGN + AESTHETIC CONSIDERATIONS



This section outlines some important areas for consideration in determining whether Cemintel Territory is suitable for the required application. The following points are not exhaustive. It is the responsibility of the Architect/building designer to ensure the design conforms to NCC requirements and other relevant building standards that may exist for the location. This guide should be read in conjunction with the NCC.

Control Joints

Movement Control Joints

Control joints provided in the panel layout should be aligned with any movement control joints provided in the framing. For example, a horizontal control joint of approximately 20-30mm is required at every storey junction (Refer to Fig. 4.01).

When undertaking building additions, a movement control joint must be installed at the junction of the existing framing and new framing. The cladding systems must be discontinuous at this joint. Refer to 'Construction Drawings and Details' section.

When setting out panels, design consideration should be given to the location of joints to ensure that minimum panel lengths and widths are met.

Horizontal Control Joints

Where frame shrinkage may be a concern, Cemintel recommends creating a horizontal break in the panelling at the first floor level or by incorporating a verandah or awning or other design element to create discontinuous panelling.

Vertical Control Joints

Vertical sealant filled control joints are required at the end of each panel (at a maximum 3030mm spacings = full length panel), at junctions with pre-formed corners, and at other wall junctions. No additional vertical control joints are required.

Vertical joints in panels must be aligned and extend for the full height of continuous panelling, although additional joints may be placed over openings for ease of installation. As the joints are expressed and sealant filled, consideration to the positioning of joints is important for aesthetic reasons. Placing joints at sides or above openings, or the use of full height windows can reduce the visual impact of joints.

A vertical control joint must also be installed when a masonry wall adjoins framed construction, and at the junction of framed additions to existing buildings, to allow for differential movement. Refer to 'Construction Drawings and Details' section.

FIGURE 4.01 Typical layout of vertical and horizontal panel joints.

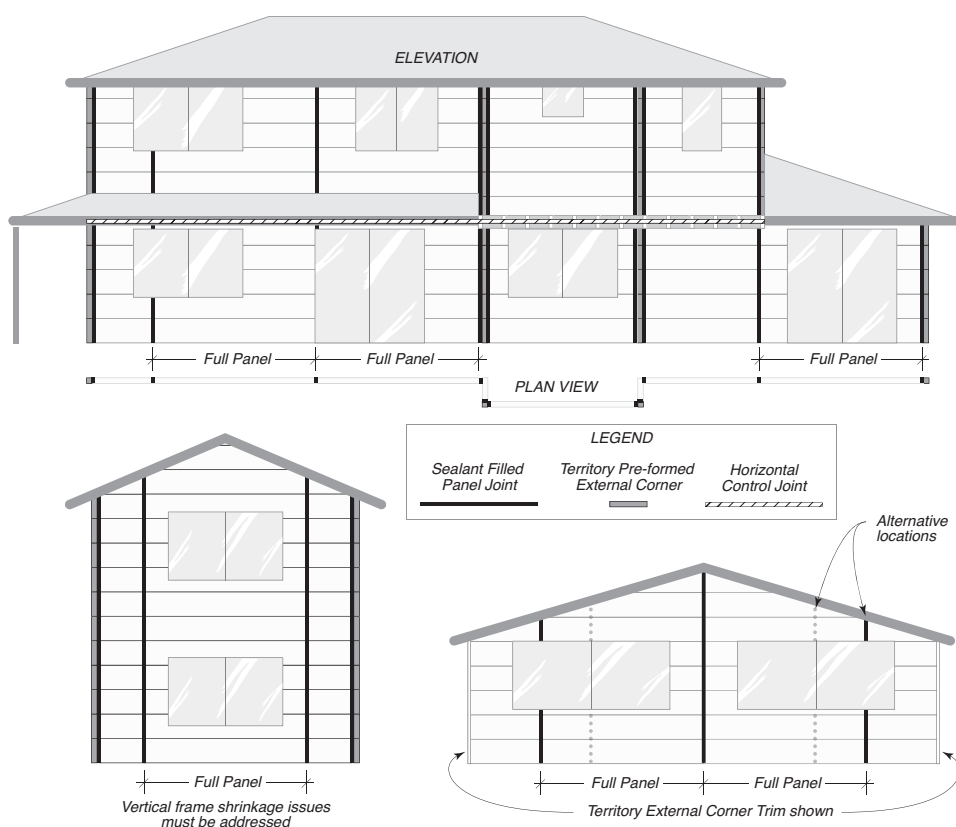



DESIGN + AESTHETIC CONSIDERATIONS

Coverage

A Cemintel Territory panel has a nominal width coverage of 455mm.

Note that the recommended minimum cut panel size is 100mm in length and 200mm in height. Anything under this will most likely result in cracking. **All cut panels must have edges sealed to protect against moisture penetration.**

Panel Coverage Calculator.

Territory Panel Rows (Height)	Coverage for Full Panels (mm nominal)
1	455
2	910
3	1365
4	1820
5	2275
6	2730
7	3185
8	3640
9	4095

Window & Door Openings

Cemintel Territory is compatible with industry standard aluminium and timber framed windows. Aluminium windows MUST NOT have sill drain holes that can direct water into the wall cavity.

With the cavity created by the clip system, particular attention needs to be given to the set out of windows and doors.

The depth of the window needs to be taken into account in the design of the building frame so that the front face of the panel is properly aligned with the window and that the flashing is installed correctly.

A nominal space of 31mm needs to be allowed for a flush finish – taking into account the 15mm cavity

(created through the use of the starter strip, clips and spacers) and 16mm panel thickness. This needs to be included in drawings for any project.

If using a rigid air barrier, sheet bracing or fire grade plasterboard, the thickness of this also needs to be accounted for to achieve a flush finish when determining window set out and reveal depths.

Refer to window detail drawing options in 'Construction Drawings and Details' section of this guide.

Eaves Junction

Options are provided to ensure air circulation through the cavity. A proprietary foam 'L Form Vent' can be concealed behind a traditional timber trim. Alternatively, a coloured metal Eave Trim is available with matching internal and external corner pieces. It is not recommended that air be vented into the roof space.

Corners

The system offers the choice of either pre-formed matching corners or metal corners. In many cases the metal corners are considered easier to install. Note that metal corners are recommended when installing onto masonry.

Face Fixings

Cemintel Territory is installed largely as a concealed fixing system. The panels are held in place by clips that are screwed to the frame. However, in some places, for example, around openings where clips cannot be fixed, face fixed nails or screws are used. A coloured touch up paint is available to cover the nails or screws in this instance. Further, depending on wind loads, there may be a requirement for extra face fixings (refer to Fig. 4.01).

DESIGN + AESTHETIC CONSIDERATIONS



Structural

Framing and Substrate Options

Cemintel Territory can be fixed to timber or steel framing as well as to masonry substrates.

For timber and steel framing, the minimum requirement shall be in accordance with the following standards:

- AS 1684 – Residential Timber-Framed Construction.
- AS/NZS 4600 – Cold-Formed Steel Structures.

The Territory horizontal installation has been evaluated for use in all Australian wind zones up to and including N6 and Cyclonic C4 in accordance with AS 4055, and for wind pressures up to 6kPa (non-cyclonic) and 4.5kPa (cyclonic) under AS/NZS 1170.2.

In highly corrosive environments, appropriate measures should be taken to protect the frame from corrosion. Refer to Corrosive Zones table in 'System Engineering' section.

It is critical that the frame is true and plumb. Industry best practice for frame tolerance is 5mm misalignment over 3000mm.

Note: depending on the chosen panel layout, double studs may be required in some locations. Refer to 'System Engineering' section.

Masonry Installation

Masonry structures are potentially more likely to be out of plumb. This guide provides a fixing solution for masonry however, the top hat has limited ability to allow for variation in the surface plane. Careful assessment should be undertaken to determine if this solution is appropriate for the specific situation.

Span tables are located in 'System Engineering' section.

Structural Bracing

Cemintel Territory panels are indirectly attached to the structural framing using clips and spacers. As a consequence, they are not designed to provide wall bracing.

Bracing must be provided in the structural framing with methods such as sheet or strap bracing. Where sheet bracing is used, the entire wall framing to be clad with Territory panels must be sheeted to maintain a uniform fixing plane. Note: window setout will be affected.

If the building requires a rigid air barrier for weatherproofing purposes (i.e., higher wind load areas), it is possible to use 6mm fibre cement sheathing as part of the bracing system. For further information, refer to the Cemintel Rigid Air Barrier guide.

Moisture Management

To ensure occupant health, safety and comfort and to protect the building's water sensitive materials from damage, a condensation management strategy with the following objectives is required:

- Prevent external weather entering the building;
- Mitigate the risks associated with the accumulation of internal moisture in a building; and
- Provide construction systems that have a drainage and drying potential.

The National Construction Code (NCC) volumes cover requirements for weatherproofing, condensation, water vapour, ventilation, air tightness and thermal performance which help manage associated risks and resist ingress of weather and groundwater into a building to minimise the impact on the health of occupants.

CSR provides several product options for thermal and moisture control, and use as air barriers. The project designer, architect or engineer is responsible for determining what is appropriate for the application.

Weatherproofing

The control of water ingress to a building is the responsibility of the building designer. All framing, wall wrap/sarking, flashings, damp proof courses and sealants must be installed in accordance with design and installation guides, the relevant product manufacturer's instructions, applicable standards and building codes. The selection of the appropriate installation system is based on many factors, but particular attention must be paid to weatherproofing to ensure adequate long-term performance.

Important: Windows must be a front draining style and have appropriate flashing to prevent moisture ingress and penetrations should be effectively sealed and allow for differential movement between the air barrier and at the cladding.

The Territory facade system has been assessed to meet the performance requirements of NCC 2022 F3P1 [2019: FP1.4] and NCC 2022 H2P2 [2019: P2.2.2]. The building designer should ensure that the published details are suitable as part of the weather resistance solution for the external building envelope.



DESIGN + AESTHETIC CONSIDERATIONS

Drained Cavity Construction

The Territory wall system acts as a drained cavity wall and has been tested to satisfy the requirements of the NCC. The cavity behind the cladding can be pressure equalised reducing the pressure differential between the cavity and external surface, reducing the risk of water entering the cavity.

A specific air barrier is required and options are available with a soft air barrier (i.e., wall wrap) and with a rigid air barrier.

Air Barriers

An air barrier behind the cladding is an essential part of the Territory weatherproofing system. The air barrier is required to reduce air leakage between the external and internal areas of the building. It is important to note that air barriers must be installed correctly as they are an integral element of a pressure equalised self-draining cavity system. The extent of the barrier, including the treatment at corners and at interactions with other facade elements, must be considered by the facade designer. Vertical cavity barriers may be required at some locations to ensure effective positive pressure zones exist within the cavity, typically at building corners.

For conventionally installed wall wrap/vapour control membrane layers, typically the internal plasterboard lining is considered the predominant air barrier in the external wall system. Alternatively, the inner lining of the ventilated and drained cavity (i.e., wall wrap, rigid air barrier, waterproofing layer, backpan) can be the air barrier. The design must ensure the air barrier is structurally adequate to resist the imposed design wind pressures.

Properly designed rigid air barriers including, fibre cement, masonry, concrete and timber sheeting all require respective detailing and sealing to be utilised as an air barrier. Alternatively, various properly designed wall wraps may be utilised. The maximum serviceability limit state wind pressure may be governed by the type of air barrier/air seal selected.

The serviceability wind pressure for the building is used to determine the suitability of a weatherproofing system. However, the design pressure for the air barrier is dependent on factors such as cavity depth, ventilation openings, and any panel gaps. The air barrier should be designed to resist the building ultimate wind pressure unless a lower value is determined by the facade engineer.

Territory Façade Wall System using Cemintel Rigid Air Barrier

The design ultimate limit state wind pressure of the Territory Horizontal Panel wall system using Cemintel Rigid Air Barrier (RAB) system is +/-6.0kPa (e.g. N6/C4).

The weatherproofing performance of Territory wall systems using Cemintel Rigid Air Barrier has been successfully tested against water ingress in accordance with the water penetration test requirements of AS 4284 for the serviceability limit state wind load of up to +3.5kPa (e.g. N6/C4).

The Territory facade wall system with a Cemintel Rigid Air Barrier (RAB) system has been assessed to meet the performance requirements of NCC 2022 F3P1 [2019: FP1.4] and NCC 2022 H2P2 [2019: P2.2.2] up to a serviceability limit state wind load of +/-3.5kPa.

Cemintel Rigid Air Barrier with the joins and perimeter effectively sealed can be used to create an air barrier system, reducing the wind pressure loading on the internal linings. Refer to Cemintel Rigid Air Barrier Design and Installation Guide for further information on pressure equalisation and construction details of the Rigid Air Barrier systems.

Territory Façade Wall System using Cemintel CW-IT Soft Air Barrier

The design ultimate limit state wind pressure of the Territory facade wall system using Cemintel Soft Air Barrier CW-IT Wall Wrap system is +/-2.5kPa. (e.g. N3/C1).

The Territory facade wall system with a Cemintel Soft Air Barrier CW-IT Wall Wrap system has been assessed to meet the performance requirements of NCC 2022 F3P1 [2019: FP1.4] and NCC 2022 H2P2 [2019: P2.2.2] up to a serviceability limit state wind load determined in accordance with AS/NZS 1170.2 for a maximum ultimate limit state wind load of +/-2.5kPa.

It is recommended that wall wraps have an air resistance greater than 0.1 MN/m³ when tested to ISO5636-5.

Cemintel Soft Air Barrier with the integrated tape (IT) joins, Bradford Plasti-Grip Washer restraint fixings and mechanically anchored perimeter effectively sealed can be used to create an air barrier system, reducing the wind pressure loading on the internal linings. Refer to Cemintel Façade and Cladding Design Guide for further information on pressure equalisation and construction details of the Soft Air Barrier system.

DESIGN + AESTHETIC CONSIDERATIONS



Territory Façade Wall System using Wall Wraps

NCC 2022 F3V1 [2019: FV1.1] and NCC 2022 H2V1 [2019: V2.2.1] and outline the weatherproofing performance verification method requirements for external walls of typical buildings falling within the following conditions:

- Maximum design ultimate limit state wind pressure of 2.5kPa (e.g., N3/C1);
- Risk score of 20 or less; and
- Uses only windows complying with AS 2047.

The design ultimate limit state wind pressure of the Territory façade wall system using wall wraps has been determined in accordance with the NCC Verification Method.

The Territory facade wall system with a Cemintel wall wrap system has been assessed to meet the performance requirements of NCC 2022 F3P1 [2019: FP1.4] and NCC 2022 H2P2 [2019: P2.2.2] up to a serviceability limit state wind load of +/-1.5kPa (e.g., N3/C1).

It is recommended that wall wraps have an air resistance greater than 0.1 MNs/m³ when tested to ISO5636-5. Wall wraps in Table 4.02 meet this air resistance requirement.

The wall wrap shall be installed in accordance with the details included in this manual. An interior wall lining is required for this system, and must be designed to resist the building interior wind pressures. Details for Gyprock plasterboard and Cemintel Wallboard installation are available in the relevant manuals.

Low Air Infiltration Requirements using Wall Wraps

Where there is a requirement for low air infiltration in the wall cavity behind the wall wrap, the joints and perimeter junctions of the wall wrap must be effectively sealed to achieve a barrier with low air infiltration, reducing the wind pressure loading on the internal linings.

Refer to the installation guidelines of the wall wrap manufacturer.

Condensation

Condensation is a complex problem and occurs as warm, moist air cools and contacts cold surfaces that are below the air's dew point. Absorptive materials such as brick, cement sheet and timber are permeable and act as a buffering material until they become saturated, whilst nonabsorptive materials such as steel and glass reach saturation quickly. Water can then accumulate and must be allowed to dry or drain away via a cavity.

Moist surfaces and the right environment can lead to mould, creating potential health issues for occupants and lead to degradation of building materials and loss of structural integrity.

The likelihood and severity of condensation is largely a function of:

- Climate (primarily temperature and humidity including seasonal and diurnal variations).
- Occupancy and building use.
- Material properties of the building envelope (including insulation material type and R-Value).
- Passive and mechanical ventilation.
- Air tightness.
- The building envelope's ability to allow or prevent the movement of vapour.
- The building envelope's ability to act as a water barrier behind the primary cladding element.
- The drying potential provided by a building envelope.

CSR recommends that architects/designers undertake a condensation risk analysis prior to selecting vapour control membranes. A rigid air barrier may be required where buildings are subject to higher wind loads, and in some climate zones may require the incorporation of a vapour control membrane in addition to the rigid air barrier. Greater use of insulation, better sealing to restrict air movement, and increased use of air conditioning leads to larger differences between the temperature and water vapour content of indoor environments and adjacent outdoor areas and greatly increases the risk of condensation at surfaces and interstitial spaces.

The Australian Building and Construction Board (ABCB), "Condensation in Buildings - Handbook", Print Version 3.2, June 2023, discusses the condensation risks and provides guidance on managing condensation. This guidance includes review of Bureau of Meteorology climate statistics (including maximum and minimum average monthly temperatures together with average monthly dew point temperatures). This highlights the likelihood of condensation which occurs when minimum temperature falls below the dew point and identifies the daytime drying potential.

Vapour Control/Vapour Permeable Membranes

The fabric of the building separates the interior and exterior environments and is subject to the movement of heat, air, water, and water vapour. Multiple materials are usually required to form effective control layers in the interstitial spaces between the exterior cladding and internal lining of a building.

04

DESIGN + AESTHETIC CONSIDERATIONS

The appropriate wall wrap for an application will depend on the local climate, building type, service wind pressure, use and orientation, material R-Value of the insulation, as well as the degree and location of ventilation.

Vapour barriers restrict the transmission of water vapour, while vapour permeable membranes allow the transmission of water vapour.

The wall wrap must have a 'water barrier' classification to AS/NZ 4201.4. A non-water barrier classification is not suitable. Wraps included in this manual, and Cemintel Rigid Air Barrier, have achieved the classification water barrier. Wall wraps must meet the requirements of AS/NZS 4200.1: Pliable building membranes and underlays – Materials and be installed in accordance with AS 4200.2 – Pliable building membranes and underlays – Installation requirements.

For conventionally installed wall wraps, the requirement to seal joints and penetrations may vary depending upon NCC, AS 4200.2 and/or state requirements, CSR recommends sealing the external wall wrap/sarking to maintain vapour and wind performance, and draught proofing effectiveness, as well as to ensure water barrier integrity. As there are a number of factors that need to be considered in assessing and managing condensation risk.

Note: "The use of Class 3 membranes such as Cemintel Rigid Air Barrier may not meet the NCC DTS requirements in some Climate Zones. For Climate Zones requiring Class 4 membranes, a Performance Solution may be completed with the use of a Class 3 membrane, where a Vapour Barrier is installed on the internal side of the insulation.

Additional literature on this subject is available from CSIRO/BRANZ/ASHRAE/ACB and CSR DesignLINK can help with this assessment.

FIGURE 4.01 Recommended CSR Products for Moisture Management of Walls

Climate Zone	Guidance on Vapour Control	Performance and Category	Recommended CSR Products ⁽¹⁾ (Refer to Table 4.02)
Warm humid, High humidity or Hot-dry (tropical, coastal, inland) climates (Zone 1, 2, 3)	Where vapour flow is typically inward, such as where the building is airconditioned for cooling, the membrane should function as a vapour barrier. Climates with varying diurnal and seasonal temperature changes can affect the direction of the water vapour flow. In most cases a vapour permeable membrane outside the insulation is recommended to avoid creating a moisture trap, allowing drying in either direction.	Vapour Barrier Class 1 or 2 or Vapour Permeable Class 3 or 4	<ul style="list-style-type: none"> Bradford Thermoseal Wall Wrap Bradford Thermoseal Wall Wrap XP Cemintel Rigid Air Barrier with a vapour barrier membrane Cemintel Rigid Air Barrier Bradford Enviroseal RW/CW/CW-IT Wall Wrap
Hot-Dry or Warm Temperate (coastal & inland) climates (Zones 4, 5)	These climates have varying diurnal and seasonal temperature changes that can affect the direction of the water vapour flow. A vapour permeable membrane outside the insulation is required to avoid creating a moisture trap, allowing drying in either direction. Where a high level of thermal insulation is used, a high degree of permeability may be required.	Vapour Permeable Class 3 or 4	<ul style="list-style-type: none"> Bradford Enviroseal RW/CW/CW-IT Wall Wrap Cemintel Rigid Air Barrier
Mild or Cool Temperate, or Cold (alpine) climates (Zones 6, 7, 8)	Where there is a strong tendency for outward migration of vapour and a high risk of condensation, vapour permeable membranes should be installed on the cold, external side of the insulation.)	Vapour Permeable Class 4	<ul style="list-style-type: none"> Bradford Enviroseal RW/CW/CW-IT Wall Wrap Cemintel Rigid Air Barrier⁽²⁾

(1) Expert guidance based on local experience should be sought.

(2) The use of Class 3 membranes such as Cemintel Rigid Air Barrier may not meet the NCC DTS requirements in some Climate Zones. For Climate Zones requiring Class 4 membranes, a Performance Solution may be completed with the use of a Class 3 membrane, where a Vapour Barrier is installed on the internal side of the insulation. CSR recommends seeking expert advice prior to specifying systems for these regions.

DESIGN + AESTHETIC CONSIDERATIONS

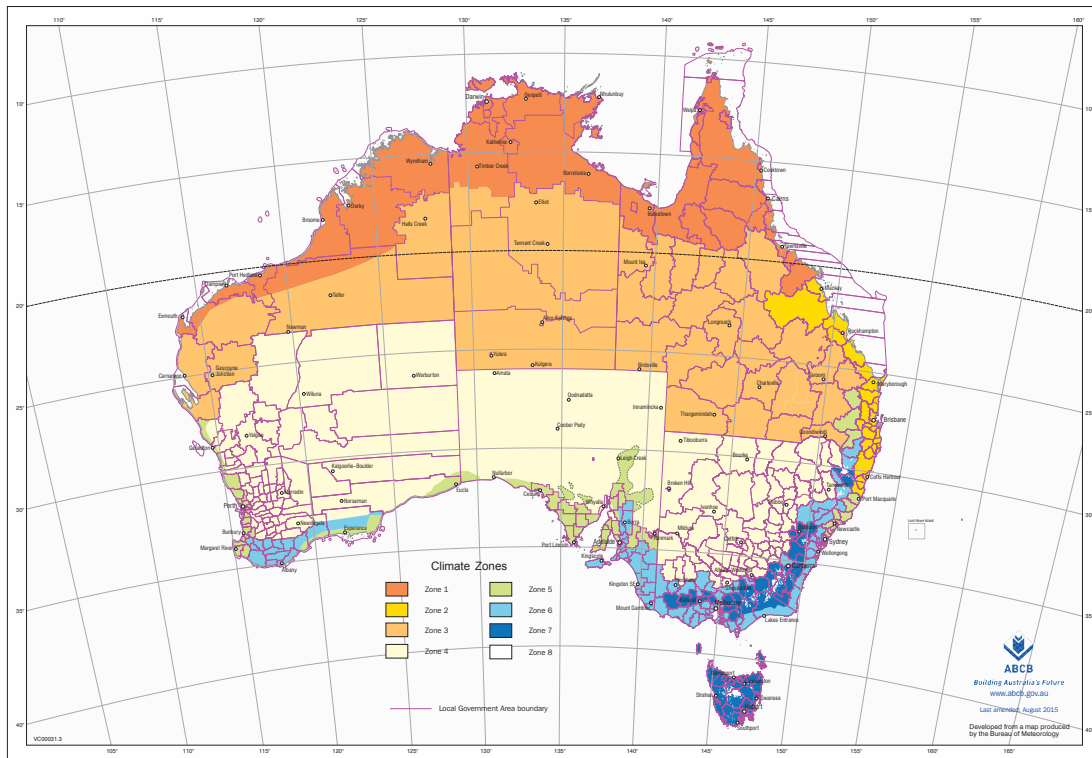

TABLE 4.02 Vapour Control Properties of CSR Products

Product	Vapour Permeance Class AS 4200.1	Vapour Permeance ASTM E 96 (µg/N.s)	Weather exposure limit prior to cladding
Thermoseal Wall Wrap XP	Class 1	<=0.0022	4 weeks
Thermoseal Firespec	Class 2	0.0022 to 0.1429	4 weeks
Thermoseal Wall Wrap	Class 2	0.0022 to 0.1429	4 weeks
Cemintel Rigid Air Barrier	Class 3	0.25	6 months (panel) 2 months (tape)
Enviroseal CW, Enviroseal CW-IT	Class 4	>1.1403	6 weeks
Enviroseal RW	Class 4	>1.1403	6 weeks

Climate Zones for Thermal Design

The following map and tables show the performance levels required for walls (and floors) under the NCC.



Step 1: Determine which climate zone your project is located in Australia from the current ABCB map, similar to above.

Step 2: From Table 4.03, determine the design conditions ('Summer' heat flow in or 'Winter' heat flow out) according to the building class and climate zone for your project. (Note building classes are defined by the NCC.)

Step 3: Refer to the wall system applicable to your construction type to determine Total R-Value.

NOTE: Some applications may achieve Total R-Values sufficient to comply with the minimum performance levels of the Deemed-to-Satisfy requirements contained in the Energy Efficiency Provision of the NCC.

TABLE 4.01 Design Conditions ('Summer' heat flow in or 'Winter' heat flow out). Source: ICANZ Handbook.

Climate Zone	1	2	3	4	5	6	7	8
		<300m Altitude	>300m Altitude					
Class 1&10	Summer		Winter					
Class 2-9	Summer						Winter	



DESIGN + AESTHETIC CONSIDERATIONS

Energy Efficiency & Thermal Design

Energy efficiency requirements for buildings are set out in the NCC, as performance requirements and acceptable construction practices, and are dependent on geographical climate zones. To meet the requirements, it is recommended that insulation be installed in the wall framing and provision of appropriate sealing of the building envelope. Check with local building authorities for minimum insulation requirements. The level of insulation provided by a wall is described by its Total R-Value.

Thermal Performance of Cemintel Wall Systems

The Gyprock The Red Book presents Cemintel external wall systems that include thermal ratings expressed as $R_{t(WINTER)}$ and $R_{t(SUMMER)}$ to represent Total R-Value numbers for the winter and summer design conditions as required by AS/NZS 4859.1, which is called upon in the NCC.

The Total R-Values presented in The Red Book are based on assumptions in accordance with the methods of AS/NZS 4859.1 – Thermal insulation materials for buildings - General criteria and technical provisions. Any included bulk insulation is a CSR Bradford product that has a material R-Value compliant with the standard, and building elements have thermal values sourced from the AIRAH handbook and NATA test results. Thermal performances quoted are based on an assessment through the insulation path. The contribution to Total R-Values depends on installation, workmanship and environmental conditions and it is assumed that cavities are ventilated.

Thermal Bridging

Thermal bridging is a path of least resistance for heat to travel, which can significantly reduce the effectiveness of insulation. An example is where a steel stud with high thermal conductivity interrupts the insulation layer. This can result in internal heat loss on a cold day and internal heat gain on a hot day. At thermal bridging locations, condensation may occur where warm, moist air contacts a colder surface.

The detrimental impact of a thermal bridge can be diminished with the installation of a thermal break, which increases the resistance for heat to travel at the thermal bridging locations. Typically, the thermal break has low thermal conductivity.

Thermal Break

For some situations, e.g. Class 2 building or Class 4 parts of a building, an envelope consisting of a metal framed wall with and external fibre-cement cladding and an internal lining directly fixed to the frame, NCC 2022 J3D6 (1) [2019: J0.5] requires a thermal break to be installed between all points of contact between the external fibre-cement cladding and the metal frame. The thermal break shall have a minimum R-Value of R0.2.

The Territory wall systems have a 'well ventilated' cavity formed by the Territory clips that separates the Territory panel cladding and metal framing. The project designer, architect or engineer is responsible for assessing the thermal bridging and determining the thermal break requirements to ensure the wall system provides an adequate Total R-Value inclusive of thermal bridging.

NCC Requirements

NCC 2022 includes changes to energy efficiency requirements. These requirements will express the R-Value of the building fabric system as the Total R-Value inclusive of thermal bridging. The Total R-Value will consider the project specific external wall configuration and materials used, so that the detrimental impact of the thermal bridging on the added insulation is captured.

Additional to the effects of thermal bridging through the framing paths of the structure, the designer will need to allow for the following:

- gaps in the bulk insulation layer in the wall system due to structural framing (i.e., studs, noggings, perimeter of wall openings) and services obstructing or limiting wall insulation coverage;
- slab edge insulation;
- wall cavity ventilation; and
- the effects of air leakage due to unsealed architraves, unsealed door jambs, unsealed gaps between windows and the masonry wall or services penetrating the inner leaf.

These effects are to be compensated for as outlined in Section J of the NCC.

For projects conforming to NCC versions prior to the NCC 2022, thermal bridging consideration is not required in the Total R-Value calculation for all building classes, such as:

- Class 1 to Class 10 buildings (all building classes) for NCC 2016 Amdt. 1 Volume One and NCC 2016 Amdt. 1 Volume Two (and earlier).
- Class 1 and Class 10 only for NCC 2019 (incl. Amdt. 1) Volume Two.

For product information, refer to 'Components + Accessories' section of this guide. Note, the insulation also improves the acoustic performance of the wall against outside noise.

Building Envelope Sealing

Building envelope sealing is pertinent to the energy efficiency performance of a building. NCC 2022 J1V4 [2019: JV4] outlines a method to verify compliance with the building sealing requirements in NCC 2022 Part J5 [2019: Part J3].

Solar Reflectance/Absorptance

In some states, it is a requirement to provide solar values for coloured product.

Cemintel Territory has been tested by the University of New South Wales to determine Solar Absorption and Reflectance as required by the BCA. The products have been tested to ASTM E 903-96 'Standard Test Method for Solar Absorptance, Reflectance and Transmittance of Materials Using Integrating Spheres'.

Values are included in the Technical Data Sheet.

DESIGN + AESTHETIC CONSIDERATIONS



Fire Performance

With regards to compliance with NCC requirements to avoid the spread of fire via the facade, two approaches are considered:

- **Deemed to Satisfy Provisions** specify that construction for fire resistance must comply with the clauses listed in Section C. In particular, NCC 2022 C2D10 [2019: C1.9] requires that all components of external walls of buildings of Type A and Type B construction are non-combustible.

Cemintel Territory facade panels can therefore be used as cladding in these external walls since they are considered to be non-combustible in accordance with NCC 2022 C2D10(6) [2019: C1.9(e)], which states that fibre reinforced cement sheeting may be used wherever a non-combustible material is required.

For wall systems requiring non-combustible materials, the combustible component in the wall, such as the Horizontal Spacer, will have to be substituted with a non-combustible component of equivalent or better performance, such as a steel top hat. Note the substitute components will need to be compatible with the other components.

- **Verification Method NCC 2022 C1V3(b) [2019: CV3(b)]** addresses the spread of fire via the facade as part of compliance with Performance Requirement NCC 2022 C1P2 [2019: CP2]. Australian Standard AS 5113:2016 provides procedures for fire propagation testing and classification of external walls of buildings according to their tendency to limit the spread of fire via the external wall and between adjacent buildings.

A classification EW is required for consideration as part of the Verification Method to obtain compliance. Cemintel Territory horizontal application has been tested in accordance with AS 5113 and achieved a classification EW.

A range of typical construction details included in the 'Installation' and 'Construction Drawings and Details' sections of this guide have been assessed as being compatible with the 'EW' classification. The assessment also allows alternative materials to be used, including the full range of Territory panels, a range of Bradford glasswool batts, Tenmat and Firefly cavity barriers, and various Gyprock™ plasterboard interior linings.

Fire Rated External Wall Systems

The Cemintel guides and Gyprock The Red Book publications provide design and installation information on the FRL rating of the Territory Series wall systems. Along with the Territory cladding, the fire rated wall systems are achieved with the inclusion of other CSR products, such as, Gyprock fire-resistant plasterboard, and Bradford insulation and sarking/wall wraps.

In accordance with NCC 2022 C2D10 [2019: C1.9] and NCC 2022 H3D2 [2019: 3.7.1.1], the following CSR products are deemed suitable for use wherever a non-combustible material is required, as:

- Cemintel products are a fibre-reinforced cement sheeting material;
- Gyprock fire-resistant products are a plasterboard material; and
- Bradford Enviroseal and Thermosteel products are sarking-type materials that do not exceed 1mm in thickness and have a Flammability Index ≤ 5 .

Design Fire Requirements

The design engineer is responsible for approving and specifying the wall system solution to ensure compliance with applicable NCC provisions, project specification, Australian Standards and any other regulatory requirements. These may include, but not limited to, the following:

- Nominating the length of fasteners to allow for the extra thickness of the fire-rated linings and maintain fastener capacity and minimum embedment;
- Selection of alternative non-combustible materials;
- Specification of the external fire-resistant lining and fixing requirements; and
- When the internal (room) wall linings that form part of the fire rated wall system, design of the areas where the linings are omitted (such as the junctions of walls, floor and roof framing, in the roof space, and at service penetrations) and determine the necessity of additional treatment such as the provision of Supplementary Fire Zone Protection.

For further information, refer to the Cemintel Facades and Cladding – Design Guide and Gyprock The Red Book publications.



DESIGN + AESTHETIC CONSIDERATIONS

Extreme Climate Conditions

Bushfire Zones

A Bushfire Attack Level (BAL) rating is a means of measuring the severity of a building's potential exposure to ember attack, radiant heat and direct flame contact. It is the responsibility of the project designer to assess the bushfire adequacy of the wall system and determine any additional details to satisfy the project bushfire requirements (refer to the NCC, AS 3959 and any other relevant regulatory requirements).

The Territory panels installed in a horizontal application have been tested to AS 1530.8.1 and the vertical application assessed. However, protection against bushfire attack requires a comprehensive and systematic approach to ensure the construction of the whole wall system is considered, that includes the specification of fire-resistant linings, framing, cavity treatment and other materials (e.g., insulation, external wall cladding), and construction details for the external walls and junctions to neighbouring elements (e.g., eaves, roofs, decks and floors). Bushfire zone walls require specific treatments, such as but not limited to, all joints in the external surface material (cladding) of walls shall be covered, sealed, overlapped, backed or butt-jointed, inclusion of a sarking-type material applied over the frame prior to fixing any external cladding, and at all gaps (e.g., vents and weepholes) in external walls shall be screened with a mesh with a maximum aperture of 2mm, made of corrosion-resistant steel or bronze. Also mesh coverings maybe required at the wall head, base, all gaps, eaves and junctions with roofs, etc., to ensure appropriate protection from fire and ember attack.

In accordance with AS 3959, the Cemintel Territory panels comply with the minimum thickness requirements of fibre-cement external cladding of Section 8 Construction Requirements for Bushfire Attack Level 40 (BAL-40) for an external wall. Territory wall systems are suitable for use on buildings located in a designated Bushfire-Prone Area subject to a Bushfire Attack Level up to and including BAL-40 when constructed in accordance with AS 3959 (and subject to state and territory variations) to meet the NCC DTS requirements.

Cemintel Territory wall systems can achieve a 30/30/30 FRL rating (or higher) from the outside with the addition of a suitable Gyprock Fyrchek MR plasterboard lining to the outside of the framing, (refer to Gyprock The Red Book 01 Design Guide) and installed according to regulations and AS 3959 Section 9 Construction Requirements for Bushfire Attack Level FZ (BAL-FZ) for an external wall. Note that a 10m setback applies from the edge of the classified vegetation to the building.

Corrosive Zones

Consideration of corrosivity zones should be taken into account. While Territory panels are not susceptible to corrosion, consideration needs to be made regarding the impact of climate conditions on system components such as fasteners, clips and metal framing, for example.

Corrosivity zones are detailed in AS 4312 and set out in the 'System Engineering' section.

The Territory components may be used in zones up to and including C4. When used in Category C3 and above, all walls which are protected by soffits must be washed down twice per year to remove salt and debris build up, particularly around window/door openings. In C4 corrosivity zones, face fixings must be Class 4 or stainless steel. The building designer is responsible for assessing the site in accordance with the standard and local conditions.

Cemintel Territory is not suitable for Corrosivity Zone C5 – Very High. This includes the beachfront in regions of rough seas and surf beaches, and inland for several hundred metres, eg. around Newcastle extending over half a kilometre from the coast. It also includes aggressive industrial areas where the environment may be acidic with a pH of less than 5.

Responsibility for the choice of fasteners in corrosive environments lies with the building designer. Note that white residue or tea staining is often a side effect of exposed fasteners in these environments. Painting and coating can offer some added protection.

Temperature Extremes

Territory panels are not warranted for use in freezing conditions in which panels are in contact with snow or extremely hot temperatures (above 50°C).

Termite Management

There is a wide variety of methods for managing termite entry to buildings, and selecting the appropriate method for any structure depends on specific risk factors and the form of construction.

Refer to local pest management services, the NCC, AS 3660: Termite Management and local building authorities for more information about the requirements for the design of a suitable termite management system.

DESIGN + AESTHETIC CONSIDERATIONS

Corrosivity Categories

ISO 9223 has suggested five corrosion zones based on the first year corrosion rate of mild steel. Refer to AS 4312 – 2019 for details regarding Australian Atmospheric Corrosivity Categories (the below highlights some general statements from this document).

TABLE 4.03

ISO 9223 category	Corrosivity	Steel Corrosion rate $\mu\text{m}/\text{y}$	Typical environment
C1	Very low	<1.3	Dry indoors
C2	Low (most areas of Australia at least 50km from the coast or at least 1km from sheltered bays would be in this category)	1.3-25	Arid/urban inland
C3	Medium (from 1km to 10-50km from breaking surf – much of metropolitan Wollongong, Sydney, Newcastle and Gold Coast are in this category)	25-50	Coastal or industrial
C4	High (primarily coastal areas - from several hundred metres to about 1km inland from breaking surf or from the shoreline to around 50m for sheltered bays)	50-80	Sea shore (calm)
C5	Very high (industrial or marine) – common offshore and on the beachfront in regions of rough seas and surf beaches – can extend inland for several hundred metres (in some areas of Newcastle extends around 500m)	80-200	Sea shore (surf)
CX	Extreme (industrial or marine) - found on offshore structures and within 50m inland of the shoreline of coasts exposed to surf or very rough seas - can extend 200m under the most severe sea conditions and 100m in tropical locations.	200-700	Sea shore (severe surf) of exposed coasts

Cyclonic Zones

Cyclonic testing on Territory resulted in it withstanding positive/negative wind pressures of 2.72kPa using the short clip and 4.5kPa using the long clip.

Extra fixings are required in cyclonic areas. Short clips and long clips are required to have 2 fixings to each stud. Refer to 'System Engineering' section for further information and span tables.

Long clip fixing

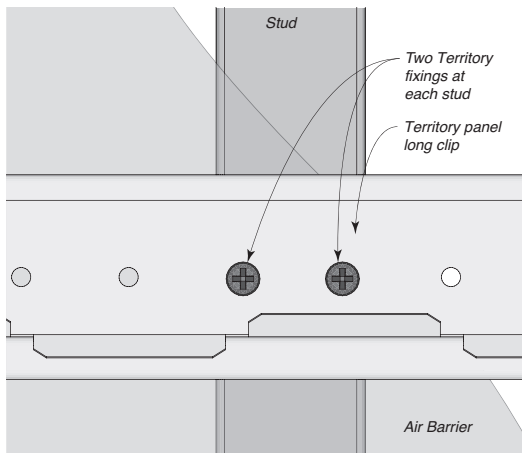

Short clip fixing

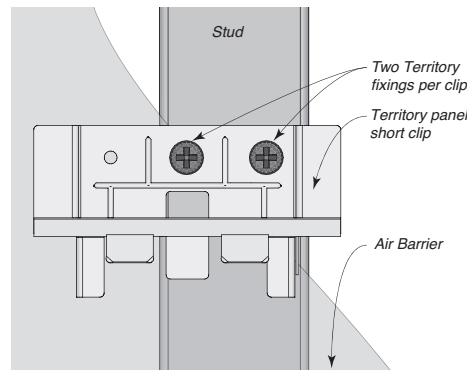

04

DESIGN + AESTHETIC CONSIDERATIONS

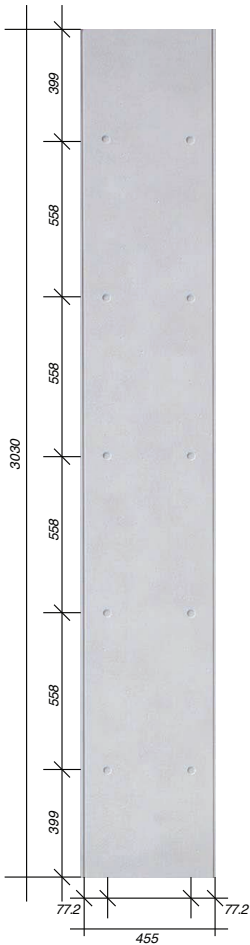

Other Design Considerations

Services

The Territory system will accommodate services that are run through the framing. Any notches or holes formed must be considered in the framing design.

Renovations

When undertaking building renovations, remove all cladding and wall wrap/sarking and insulation from the original wall framing. Ensure the condition of the framing is in accordance with current requirements and is as true and as plumb as possible (within accepted industry tolerance of 5mm misalignment over 3000mm).

Install additional framing as required, insulation, air barrier and flashing.

Limitations

Territory is not recommended and not warranted for the following applications:

- Panels with non-vertical face (eg. parapet capping).
- Wet areas such as bathrooms.
- Chimney cladding.
- Exposure to temperatures greater than 50°C.
- Non vented parapet cladding.
- Contact with standing snow or ice.
- Fixing of tiles or other materials to the face of the panel.
- The face is painted.

The above listing is not intended to be comprehensive. If in doubt, please contact Cemintel.

Territory QUARRY Urban Grey

Note that the Territory QUARRY Urban Grey panel has “dimples” across the surface to replicate the look of formwork and these need to be considered in the design phase. Extra product may need to be ordered accordingly. The Territory QUARRY Concrete has the same colour/finish but has a flat profile (ie no “dimples”).

Touch-Up Paint

Use for nail heads, cut edges at window heads and other visible blemishes. If 304 nail heads require coating, use a primer for bare steel such as Dulux All Metal Primer prior to coating with the appropriate coloured paint.

Wash Down Process

Panels have been coated with a Nichiguard factory finish which has ‘self cleaning’ properties when exposed to rain water.

Consequently, ongoing maintenance should be limited to occasional rinse down.

When rinsing down panels, use no more than 700 psi (50kh/cm²) of water pressure at a minimum of 3m distance from the face of the wall. Water pressure should be applied downward to avoid forcing water into tongue and groove joints.

Territory panels should be washed with water only. Do not use detergents or scrub with a brush as this may damage the Nichiguard surface coating.

Inspection, Repair and Maintenance

The durability of the Cemintel Territory range can be enhanced by periodic inspection and maintenance. Inspections should include examination of the coatings, flashings and seals. Any cracked or damaged finish or seals which would allow water ingress must be repaired immediately by resealing the affected area, or by removing the panel and replacing sealant. Any damaged flashings, sheets or sealant must be replaced as for new work.

Regularly inspect panel surfaces and follow wash-down procedures when required. Small blemishes can be repaired using touch-up paint or other approved paint.

Ensure ventilation and drainage gaps between panels and flashings are clear of any debris.

It is recommended storing additional panels in case any panels are damaged in the future. Any small chips can be painted over with touch up paint which both hides the underlying panel colour and seals the panel to prevent moisture ingress.

If a whole panel needs to be replaced, the panels which sit above it will need to be removed one by one from the heading, and then reassembled with joints resealed.

05

COMPONENTS + ACCESSORIES

05

COMPONENTS + ACCESSORIES

Note: Codes can change from time to time. Refer to the website for the current list of components prior to ordering.

Cemintel Territory Panels and Accessories

Product Name	Panel (2 Pk)	Touch-Up Paint	Primer	Coloured Joint Sealant Sausages 500ml	Pre-formed External Corner Horizontal#
WOODLANDS Smoked	133976	165354	111616	178928	134409
WOODLANDS Teak	133975	165355	111616	178923	140727
WOODLANDS Grey Gum	472376	478226	111616	178921	472325
WOODLANDS Ebony	163108	165356	111616	472321	163109
WOODLANDS Birch	472366	478227	111616	178927	472327
WOODLANDS Limed	163175	165358	111616	178927	163225
WOODLANDS Kwilla Slats	472361	478229	111616	472310	472329
QUARRY Urban Grey	133977	165372	111616	178922	134410
QUARRY Concrete	134702	165372	111616	178922	134410
RIDGE Black	472373	478301	111616	472321	472336
RIDGE WHITE	472374	478302	111616	178848	472337
BRICK Red Rustic	472367	488750	111616	484739	484734
BRICK White Rustic	472359	488753	111616	484742	484738
BRICK Grey Rustic	472368	488751	111616	484740	484736
BRICK Black Modern	472375	488752	111616	178921	484737





Pre-formed External Corners are manufactured to match panels. Internal measurement – 70mm x 70mm. Coverage nominal 86mm x 86mm x 455mm.

Cemintel Rigid Air Barrier

Product Name	Width (mm)	Length (mm)	Thickness (mm)	Product Code
Cemintel Rigid Air Barrier	1200	3000	6	170076

OTHER ACCESSORIES/TOOLS









Note: The length of the fixings will need to be increased to ensure the same or greater embedment depth is obtained when additional layers are added, such as a Rigid Air Barrier (RAB), fire-rated linings, and/or thermal break materials.

Accessories	Description	Size	Quantity	Product Code
	Screws for timber framing – used to fix starter strip, clips and other components. Stainless steel SUS410 grade and clear coated.	4.1mm Ø x 35mm	500 per pack	105366
	Screws for timber framing – for fixing components over materials such as rigid air barrier or bracing sheet. Galvanised steel, Class 3. Minimum embedment of 35mm.	8g x 57mm	100 per pack	117839
	Nails for timber framing – for fixing Territory panels at soffit line and other locations where required. Ribbed shank, flat head, stainless steel 304 grade. Pre-drill panels for all nails.	3mm Ø x 75mm	230 per pack	105298
	Screws for steel framing – for fixing starter strip, clips and other components. Class 3, 8g, self-drilling, button head, Phillips drive	8g x 20mm	1000 per pack	113604
	Screws for steel framing – for face fixing Territory panels at soffit line and other specified locations. Class 3, self-drilling, CSK self-embedding head, Phillips drive. Suitable for 0.75mm BMT minimum G2 steel framing.	10g x 55mm	500 per pack	113603

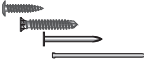
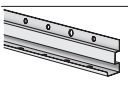
COMPONENTS + ACCESSORIES

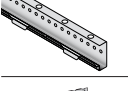
05

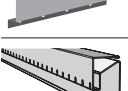

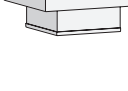
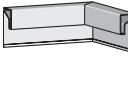



Note: Codes can change from time to time. Refer to the website for the current list of components prior to ordering.

Note: The length of the fixings will need to be increased to ensure the same or greater embedment depth is obtained when additional layers are added, such as a Rigid Air Barrier (RAB), fire-rated linings, and/or thermal break materials.				
Accessories	Description	Size	Quantity	Product Code
	Screws for masonry framing – for fixing start strip, clips and other components onto Rondo H515 Top Hats. Class 3, 8g, self-drilling, button head, Phillips drive.	8g x 12mm	1000 per pack	162931
	Screws for masonry framing – for face fixing panels at soffit line and other locations where required onto Rondo H515 Top Hats. Class 3, self-drilling, CSK self-embedding head, Phillips drive. Also used for fixing panel to metal corner.	10g x 45mm	1000 per pack	165665
	Fasteners – to fix backing strip and other components to framing. <ul style="list-style-type: none"> • For fixing to timber framing – galvanised clout, 40 x 1.6mm • For fixing to steel framing – button head screws, Class 3, 6g x 40mm self-drilling, Phillips drive • For fixing to H515 Top Hat – button head screws 8g, self-drilling, Phillips drive, 12mm for fixing starter strip and clip • Fixing over Gyprock Fyrchek MR linings - 10g x 65mm galvanised steel, Class 3, screw. Minimum embedment of 35mm. 		Supplied by others	
	Horizontal Panel Starter Strip – steel profile used at the base to locate the first row of panels. Provides 15mm offset from face of studs. Manufactured from 1.2BMT steel with Galvalume AZ150 corrosion resistant coating	3030mm	1 each	136823
	15mm Horizontal Panel Clip – fixed to the framing to retain the tongue and groove edges of panels. Manufactured from SuperDyma corrosion resistant coated steel.	72mm x 45mm x 15mm	50 per pack	105364
	15mm Corner Clip – fixed to the framing to retain the tongue and groove edges of the pre-formed external corner. Manufactured from SuperDyma corrosion resistant coated sheet.	45mm x 45mm x 15mm	24 per pack	153018
	Horizontal Long Panel Clip – fixed to the framing to retain the tongue and groove edges of panels. Manufactured from SuperDyma corrosion resistant coated steel. For use in cyclonic conditions.	2997mm	1 each	471948
	15 x 50mm Horizontal Spacer – for packing between framing and panels at eaves and other locations wherever face fixing is required. Manufactured in extruded plastic.	15mm x 50mm x 1200mm	1 each	111502
	Steel Top Hat – for framing on masonry substrate. Rondo H515. Manufactured from galvanised (Z275) 1.15mm BMT steel. Requires screws 8G, self-drilling, button head, Phillips drive 12mm for fixing starter strip and short [and long] clips to H515 Top Hat	80mm x 15mm with 50mm face 0.91 kg/m	1 each – 3.6m 1 each – 7.2m	12884 100896
	Steel Top Hat – 1.2mm thick ZAM steel suitable for C4 applications.	75mm x 15mm with 45mm face	1 each – 2.99m	194877
	Eaves Trim – provides joint at eaves trim corner. Powder coated finish on 0.35mm BMT steel with Galvalume AZ150 corrosion resistant coating.	60 x 26 x 3030mm	1 each Charcoal Pearl Silver White	471393 471413 471414 471412
	Eaves Trim External Corner – provides joint at eaves trim corner. Powder coated finish on 0.35mm BMT steel with Galvalume AZ150 corrosion resistant coating.	100mm x 100mm	1 each Charcoal Pearl Silver White	471411 471395 471396 471397
	Eaves Trim Internal Corner – provides joint at eaves trim corner. Power coated finish on 0.35mm BMT steel with Galvalume AZ150 corrosion resistant coating.	150mm x 150mm	1 each Charcoal Pearl Silver White	471394 471398 471399 471410

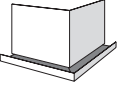
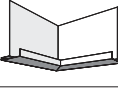
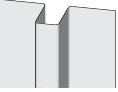
05

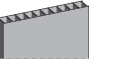
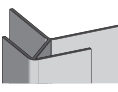
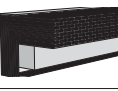
COMPONENTS + ACCESSORIES











Note: Codes can change from time to time. Refer to the website for the current list of components prior to ordering.

Accessories	Description	Size	Quantity	Product Code
	Soffit Trim – provides finish at soffit edge as well as cavity ventilation and cavity closure below battens. Powder coated finish on 0.35mm BMT steel with Galvalume AZ150 corrosion resistant coating.	60mm x 3030mm (for 15mm cavity)	1 each White	134448
	Soffit Trim External Corner – provides joint at soffit trim corner. Powder coated finish on 0.35mm BMT steel with Galvalume AZ150 corrosion resistant coating.	100mm x 100mm	Pack of 2 White	134396
	Soffit Trim Internal Corner – provides joint at soffit trim corner. Powder coated finish on 0.35mm BMT steel with Galvalume AZ150 corrosion resistant coating.	100mm x 100mm	Pack of 2 White	134430
	Joint Backing Strip Double Flange – used at vertical joints to fill cavity and provide a backing for sealant. Manufactured in 0.3mm BMT steel with Galvalume AZ150 corrosion resistant and bond breaker coating. Forms 10mm wide express joint.	3030mm	1 each	122804
	Joint Backing Strip Single Flange – used at vertical internal corner joints and at openings to fill cavity and provide a backing for sealant. Manufactured in 0.3mm BMT steel with Galvalume AZ150 corrosion resistant and bond breaker coating.	2000mm	1 each	111500
	Corner Backing Angle – metal angle flashing used in some corners. Manufactured from steel with Galvalume AZ150 corrosion resistant coating.	50mm x 50mm x 3030mm	1 each	111498
	15 x 90mm Vertical Spacer – for use with metal corners.	15mm x 90mm x 2000mm	1 each	123595
	External Metal Corner Trim – anodised aluminium extrusion used to dress and finish external corners.	60mm x 65mm x 3030mm	1 each Charcoal Pearl Silver	126961 135040 135041
	L-Form Cavity Vent – used at parapet, soffits and horizontal control joints to provide air flow while maintaining vermin proofing. Has self-adhesive EPDM tape for fixing into flashing/capping and compressible foam filler attached internally.	1200mm	1 each	129750
	Cemintel Rigid Air Barrier*	1200mm x 3000mm x 6mm	Pack of 30 sheets	170076
	Enviroseal™ RW Plus Classification – Class 4 Vapour Permeable	1350mm x 30m	1 roll	483000
		1500mm x 30m	1 roll	478759
	Enviroseal™ RW Classification – Class 4 Vapour Permeable	1500mm x 50m	1 roll	118153
	Enviroseal™ CW Classification – Class 4 Vapour Permeable	1500mm x 50m	1 roll	114175
	Enviroseal™ CW-IT Classification – Class 4 Vapour Permeable	1500mm x 50m	1 roll	134863
	Thermoseal™ Wall Wrap Classification – Non-permeable reflective Water Barrier	1350mm x 30m	1 roll	40483
		1350mm x 60m	1 roll	15128
	Thermoseal™ Firespec Classification – Non-permeable reflective Water Barrier	1500mm x 30m	1 roll	164674
	Enviroseal Hightack Tape – used to seal wall wrap at overlap joints, around openings, for repairs and at flashings. Black, single sided, aggressive adhesive tape with a high initial grab and flexible carrier.	60mm x 25m	1 roll	160950 155170
	Enviroseal SLS Flexi Tape – used to tape corners of openings.	60mm x 25m	1 roll	117688
	Enviroseal™ Double Sided Tape	24mm x 50m	1 roll	121430
	Reinforced Aluminium Foil Tape	48mm x 50m	1 carton (24)	17366
	Bradford Plasti-Grip Washers	45 x 5mm	1 carton (1000)	136770

COMPONENTS + ACCESSORIES

05

Note: Codes can change from time to time. Refer to the website for the current list of components prior to ordering.

Accessories	Description	Size	Quantity	Product Code
INSULATION				
	Bradford Gold HP Wall Batts – R2.0 (75mm)	1160mm x 420mm	12 pack	152166
		1160mm x 570mm	12 pack	152192
	Bradford Gold HP Wall Batts – R2.5 (90mm)	1160mm x 420mm	9 pack	181430
		1160mm x 570mm	9 pack	181471
	Bradford Gold HP Wall Batts – R2.7 (90mm)	1160mm x 420mm	5 pack	152191
		1160mm x 570mm	5 pack	152197
TOOLS				
	Backing Rod – used to enable correct filling of joints with sealant. Also used as an air seal at window openings and construction junctions. The diameter of backing rod must be appropriate for the width of the gap being filled.	10mm diameter x 50m roll	1 each	11177
	Intumescent Barrier – used at slab edges in AS 5113 construction. Tenmat FF 102/50	6mm x 75mm x 1m	Supplied by others	
	Sealant Bond Breaker Tape – used behind sealant to prevent 3-sided bonding	48mm x 3mm x 25m	1 each	13172
	Cemintel Edge Sealer – for sealing panel edges after on-site cutting	200ml	1 each	100166
		2ltr	1 each	180928
OTHER TOOLS				
	Makita Plunge Saw Kit (1300W) includes 1400mm guide rail and bonus 165mm fibre cement saw blade – excellent for cutting cement based sheets	165mm	1	165485
	Makita 165mm Fibre Cement Saw Blade – ideal for use with the Makita Plunge saw and other 165mm circular saws fitted with vacuum extraction systems	165mmx20x4T	1	165486
	FESTOOL DSC-AGP 125 – Diamond Blade Cutting and Grinding Tool. Used to provide neat and accurate bevelled edges	125mm	1	107207
	FESTOOL TS 55 EBQ Plunge Cut Saw – with 1400mm Guide Rail. Precise plunge cuts in materials up to 55mm thick.	160mm	1	121400
	FESTOOL Diamond Tipped Blade for TS 55 – for cutting all fibre cement sheet products	160mm	1	112647
	Cemintel Power Saw Blade – specifically designed for cutting pre-finished cement based sheets. Ideal for use with dustless circular saws fitted with vacuum extraction systems. 15000 RPM max.	125mm	1	134449



SYSTEM ENGINEERING

SYSTEM ENGINEERING



Design, Detailing And Performance Responsibilities

Territory External Wall System

Cemintel engages independent testing laboratories to test and report on the performance of a wall in accordance with the relevant Australian Standards. Consultants with relevant experience will use these test reports to provide opinions and assessments that extend the tested arrangement to include various on-site installation configurations and details that meet appropriate criteria performance.

Project Consultants (Structural, Fire, Acoustic, Etc.)

These consultants are typically responsible for the following:

- Opinions on expected laboratory performance of wall configurations that vary from actual test configuration, such as substitution products and components.
- Judgements about expected field performance using laboratory test reports and practical experience.
- Design, specification and certification of structural, fire, acoustic, durability, weather tightness and any other required performance criteria for individual projects.

This involves the design and selection of building elements, such as wall and floors and their integration into the building considering the following:

- Interface of different building elements and to the structure / substrate.
- Wall and floor junctions.
- Penetrations.
- Flashing issues.
- Room / building geometry.
- Acoustic and water penetration field-testing.

Design Responsibility

Panels, top hats and structural framing are required to resist wind loads that are specific to the building site. Additional 'local pressure factors' can apply to the panels and top hats in accordance with the wind code AS/NZS 1170.2. It is recommended that the Architect/Building Designer assigns the responsibility for the facade design to the Project Engineer. Once wind loads have been determined, top hat spans, fastener spacings, and sheet fixing details may be selected from the appropriate tables in this manual.

It is also the responsibility of the Architect/Building Designer to select the appropriate corrosivity category. Refer to appropriate details in this guide.

The performance levels of walls documented in this guide are either what is reported in a test or the documented opinion of consultants. Performance in projects is typically the responsibility of:

Project Certifier and/or Builder

These professionals are typically responsible for:

- Identifying the performance requirements for the project in accordance with the NCC and clearly communicating this to the relevant parties.
- Applicability of any performance characteristics supplied by Cemintel including test and opinions for the project.
- The project consultants' responsibilities detailed above if one is not engaged in the project.

Cemintel does not provide consulting services. Cemintel only provides information that has been prepared by others and therefore shall not be considered experts in the field.

Any party using the information contained in this guide or supplied by Cemintel in the course of a project must satisfy themselves that it is true, current and appropriate for the application, consequently accepting responsibility for its use.

It is the responsibility of the Architect/Building Designer and engineering parties to ensure that the details in this design guide are appropriate for the intended application.

The recommendations in this guide are formulated along the lines of good building practice, but are not intended to be an exhaustive statement of all relevant data.

Cemintel is not responsible for the performance of constructed walls, including field performance, and does not interpret or make judgements about performance requirements in the NCC in a specific project application.

Note: it is the responsibility of the Project Engineer to specify the connection of the top hats to the support structure. It is also the responsibility of the Project Engineer to calculate the wind loads for the cladding of a project.



SYSTEM ENGINEERING

Span Tables / Wind Loads

Timber Framing – RESIDENTIAL – NCC Class 1 and Class 10

TABLE 6.01 Territory Fixing Requirements for timber framing – based on wind classification
– studs at 600mm maximum centres

Wind Classification (AS 4055)	PANEL ZONE Minimum Fixing Requirements for areas greater than 1200mm from an External Building Corner	CORNER ZONE Minimum Fixing Requirements for areas less than 1200mm from an External Building Corner
N1	Clips @ 600mm cts;	Clips @ 600mm cts;
N2	Clips @ 600mm cts;	Clips @ 600mm cts;
N3	Clips @ 600mm cts;	Clips @ 600mm cts;
N4	Clips @ 600mm cts;	Clips @ 600mm cts + 1 Face Nail;
N5	Clips @ 600mm cts;	Clips @ 600mm cts + 1 Face Nail;
N6	Clips @ 600mm cts + 1 Face Nail;	Clips – NA
C1	Clips @ 600mm cts;	Clips @ 600mm cts;
C2	Clips @ 600mm cts;	Clips @ 600mm cts + 1 Face Nail;
C3	Clips @ 600mm cts;	Clips @ 600mm cts + 1 Face Nail;
C4	Clips @ 600mm cts + 1 Face Nail;	Clips – NA

Notes:

1. "Clips" here refers to either Long or Short Clips.
2. Where Rigid Air Barrier is used, closer stud centres may apply. Refer to Tables 6.10 & 6.11.

Timber Framing – COMMERCIAL & OTHER – NCC Class 2 to Class 9

TABLE 6.02 Territory Fixing Requirements for timber framing – based on wind pressures

Design Wind Pressure (Ultimate) (kPa)	Minimum Fixing Requirements
0 – 2.50	Clips @ 600mm cts
2.50 – 4.0	Clips @ 600mm cts + 1 Face Nail

Notes:

1. "Clips" here refers to either Long or Short Clips.
2. Where Rigid Air Barrier is used, closer stud centres may apply. Refer to Tables 6.12 & 6.13.
3. Design wind pressures apply to both negative and positive pressures.

SYSTEM ENGINEERING



Steel Framing – RESIDENTIAL – NCC Class 1 and Class 10

TABLE 6.03 Territory Fixing Requirements for Steel Framing – Based on Wind Classification – Studs as per clip centres

Wind Classification (AS 4055)	PANEL ZONE – Minimum Fixing Requirements for areas greater than 1200mm from an External Building Corner		
	Steel Frame Metal Thickness		
	0.5mm	0.75mm	1.2mm
N1	Clips @ 600mm cts	Clips @ 600mm cts	Clips @ 600mm cts
N2	Clips @ 600mm cts	Clips @ 600mm cts	Clips @ 600mm cts
N3/C1	Clips @ 600mm cts	Clips @ 600mm cts	Clips @ 600mm cts
N4/C2	Clips @ 600mm cts + 1 Face Screw	Clips @ 600mm cts	Clips @ 600mm cts
N5/C3	N/A	Clips @ 600mm cts + 1 Face Screw	Clips @ 600mm cts
N6/C4	N/A	Clips @ 600mm cts + 1 Face Screw	Short Clip @ 600mm cts + 1 Face Screw or Long Clip @ 600 cts

Notes:

1. "Clips" here refers to either Long or Short Clips.
2. Where Rigid Air Barrier is used, closer stud centres may apply. Refer to Tables 6.10 & 6.11.

Wind Classification (AS 4055)	CORNER ZONE – Minimum Fixing Requirements for areas less than 1200mm from an External Building Corner		
	Steel Frame Metal Thickness		
	0.5mm	0.75mm	1.2mm
N1	Clips @ 600mm cts	Clips @ 600mm cts	Clips @ 600mm cts
N2	Clips @ 600mm cts + 1 Face Screw	Clips @ 600mm cts	Clips @ 600mm cts
N3/C1	Clips @ 600mm cts + 1 Face Screw	Clips @ 600mm cts	Clips @ 600mm cts
N4/C2	Clips @ 600mm cts + 2 Face Screws	Clips @ 600mm cts + 1 Face Screw	Short Clip @ 600mm cts + 1 Face Screw or Long Clip @ 600 cts
N5/C3	N/A	Clips @ 600mm cts + 2 Face Screws	Clips @ 600mm cts + 1 Face Screw
N6/C4	N/A	Clips @ 600mm cts + 2 Face Screws	Clips @ 600mm cts + 1 Face Screw

Notes:

1. "Clips" here refers to either Long or Short Clips.
2. Where Rigid Air Barrier is used, closer stud centres may apply. Refer to Tables 6.10 & 6.11.
3. Design wind pressures apply to both negative and positive pressures.



SYSTEM ENGINEERING

Steel Framing – COMMERCIAL – NCC Class 2 to Class 9 – Non-Cyclonic only

TABLE 6.04 Territory Fixing Requirements for steel framing – based on wind pressures

Design Wind Pressure (Ultimate) (kPa)	MINIMUM FIXING REQUIREMENTS Steel Frame Metal Thickness		
	0.55mm	0.75mm	1.15mm
1	Clips @ 600mm cts	Clips @ 600mm cts	Clips @ 600mm cts
1.5	Clips @ 600mm cts + 1 Face Screw	Clips @ 600mm cts	Clips @ 600mm cts
2	Clips @ 600mm cts + 1 Face Screw	Clips @ 600mm cts	Clips @ 600mm cts
2.5	Clips @ 450mm cts + 1 Face Screw	Clips @ 600mm cts + 1 Face Screw	Clips @ 600mm cts
3	Clips @ 450mm cts + 1 Face Screw	Clips @ 600mm cts + 1 Face Screw	Short Clip @ 600mm cts + 1 Face Screw or Long Clip @ 600 cts
3.5	Clips @ 300mm cts + 1 Face Screw	Clips @ 600mm cts + 1 Face Screw	Clips @ 600mm cts + 1 Face Screw
4	Clips @ 300mm cts + 1 Face Screw	Clips @ 450mm cts + 1 Face Screw	Clips @ 600mm cts + 1 Face Screw
4.5	Clips @ 300mm cts + 1 Face Screw	Clips @ 450mm cts + 1 Face Screw	Clips @ 600mm cts + 1 Face Screw
5	NA	Clips @ 450mm cts + 1 Face Screw	Clips @ 600mm cts + 1 Face Screw
5.5	NA	Clips @ 300mm cts + 1 Face Screw	Clips @ 600mm cts + 1 Face Screw
6	NA	Clips @ 300mm cts + 1 Face Screw	Clips @ 600mm cts + 1 Face Screw

Notes:

1. "Clips" here refers to either Long or Short Clips.
2. Where Rigid Air Barrier is used, closer stud centres may apply. Refer to Tables 6.12 & 6.13.

Steel Framing – COMMERCIAL – NCC Class 2 to Class 9 – Alternative No Face Fixing – Non-Cyclonic only

TABLE 6.05 Territory Fixing Requirements for steel framing – based on wind pressures

Design Wind Pressure (Ultimate) (kPa)	MINIMUM FIXING REQUIREMENTS Steel Frame Metal Thickness		
	0.55mm	0.75mm	1.15mm
1	Clips @ 600mm cts	Clips @ 600mm cts	Clips @ 600mm cts
1.5	Clips @ 450mm cts	Clips @ 600mm cts	Clips @ 600mm cts
2	Clips @ 300mm cts	Clips @ 600mm cts	Clips @ 600mm cts
2.5	NA	Clips @ 450mm cts	Clips @ 600mm cts
3	NA	Clips @ 300mm cts	Short Clip @ 450mm cts or Long Clip @ 600mm cts
3.5	NA	Clips @ 300mm cts	Short Clip @ 300mm cts or Long Clip @ 450mm cts
4	NA	Clips @ 300mm cts	Short Clip @ 300mm cts or Long Clip @ 450mm cts
4.5	NA	NA	Clips @ 300mm cts
5	NA	NA	Clips @ 300mm cts

Notes:

1. "Clips" here refers to either Long or Short Clips.
2. Where Rigid Air Barrier is used, closer stud centres may apply. Refer to Tables 6.12 & 6.13.
3. Design wind pressures apply to both negative and positive pressures.

Steel Framing – COMMERCIAL – NCC Class 2 to Class 9 – Cyclonic

TABLE 6.06 Territory Fixing Requirements for steel framing – based on wind pressures in cyclonic regions

Design Wind Pressure (Ultimate) (kPa)	MINIMUM FIXING REQUIREMENTS Steel Frame Metal Thickness
	1.15mm
0 – 2.72	Short Clip @ 450mm cts
2.72 – 4.25	Long Clip @ 450mm cts

SYSTEM ENGINEERING



Masonry Substrates

Masonry wall must be structural and constructed from brick, concrete or concrete block in accordance with the relevant building codes. It is important the wall is plumb and true. Note the H515 Top Hat has limited ability for variations across the plane of the surface. Masonry fasteners must be designed by the project engineer.

Masonry – RESIDENTIAL – NCC Class 1 and Class 10

TABLE 6.07

Wind Classification (AS 4055)	PANEL ZONE Minimum Fixing Requirements for areas greater than 1200mm from an external building corner	CORNER ZONE Minimum Fixing Requirements for areas less than 1200mm from an external building corner
N1	Clips @ 600mm cts	Clips @ 600mm cts
N2	Clips @ 600mm cts	Clips @ 600mm cts
N3/C1	Clips @ 600mm cts	Clips @ 600mm cts
N4/C2	Clips @ 600mm cts	Short Clip @ 600mm cts + 1 Face Screw or Long Clip @ 600mm cts
N5/C3	Clips @ 600mm cts	Clips @ 600mm cts + 1 Face Screw
N6/C4	Clips @ 600mm cts + 1 Face Screw	Clips @ 600mm cts + 1 Face Screw

Notes:

1. "Clips" here refers to either Long or Short Clips.
2. Design wind pressures apply to both negative and positive pressures.
3. Maximum H515 Top Hat spacing as per clip fixing centres.

Masonry – COMMERCIAL – NCC Class 2 to Class 9 – Non-Cyclonic

TABLE 6.08

Design Wind Pressure (Ultimate) (kPa)	Minimum Fixing Requirements (Top Hats & Clip)
1	Clips @ 600mm cts
1.5	Clips @ 600mm cts
2	Clips @ 600mm cts
2.5	Clips @ 600mm cts
3	Short Clip @ 600mm cts + 1 Face Screw or Long Clip @ 600mm cts
3.5	Clips @ 600mm cts + 1 Face Screw
4	Clips @ 600mm cts + 1 Face Screw
4.5	Clips @ 600mm cts + 1 Face Screw
5	Clips @ 600mm cts + 1 Face Screw
5.5	Clips @ 600mm cts + 1 Face Screw
6	Clips @ 600mm cts + 1 Face Screw

Notes:

1. "Clips" here refers to either Long or Short Clips.
2. Maximum H515 Top Hat spacing as per clip fixing centres.

Masonry – COMMERCIAL – NCC Class 2 to Class 9 Alternative – No Face Fixing – Non-Cyclonic

TABLE 6.09

Design Wind Pressure (Ultimate) (kPa)	Minimum Fixing Requirements (Top Hats & Clip)
1	Clips @ 600mm cts
1.5	Clips @ 600mm cts
2	Clips @ 600mm cts
2.5	Clips @ 600mm cts
3	Short Clip @ 450mm cts or Long Clip @ 600mm cts
3.5	Short Clip @ 300mm cts or Long Clip @ 450mm cts
4	Short Clip @ 300mm cts or Long Clip @ 450mm cts
4.5	Clips @ 300mm cts
5	Clips @ 300mm cts

Notes:

1. "Clips" here refers to either Long or Short Clips.
2. Maximum H515 Top Hat spacing as per clip fixing centres.



SYSTEM ENGINEERING

Rigid Air Barrier Design

Rigid air barrier sheet installed in the vertical direction

TABLE 6.10

Wind Classification*	Stud Centres (mm)	
	Panel Zone	Corner Zone
N1	600	600
N2	600	600
N3/C1	600	450
N4/C2	600	400
N5/C3	450	300
N6/C4	450	300

Note: for specific installation information, refer to the Cemintel Rigid Air Barrier Design and Installation Guide.
* refer to Span Tables, for Wind Classifications applicable to the vertical installation of Territory panels.

Rigid air barrier sheet installed in the horizontal direction

TABLE 6.11

Wind Classification*	Stud Centres (mm)	
	Panel Zone	Corner Zone
N1	600	600
N2	600	600
N3/C1	600	600
N4/C2	600	450
N5/C3	450	400
N6/C4	450	300

Note: for specific installation information, refer to the Cemintel Rigid Air Barrier Design and Installation Guide.
* refer to Span Tables, for Wind Classifications applicable to the horizontal installation of Territory panels.

Rigid air barrier sheet installed in the vertical direction

TABLE 6.12

Stud Centres (mm)	Wind Loading* (Ultimate) (kPa)
600	1.14
450	2.03
400	2.57
300	4.57

Note: for specific installation information, refer to the Cemintel Rigid Air Barrier Design and Installation Guide.
* refer to Span Tables, for Maximum Design Wind Pressure (Ultimate) values applicable to the vertical installation of Territory panels.

Rigid air barrier sheet installed in the horizontal direction

TABLE 6.13

Stud Centres (mm)	Wind Loading* (Ultimate) (kPa)
600	1.76
450	3.13
400	3.96
300	7.0

Note: for specific installation information, refer to the Cemintel Rigid Air Barrier Design and Installation Guide.
* refer to Span Tables, for Maximum Design Wind Pressure (Ultimate) values applicable to the horizontal installation of Territory panels.

Cemintel Soft Air Barrier Design

Soft Air Barrier to be installed in the following wind load situations

TABLE 6.14 Wall Wrap and Plasti-Grip spacing requirements for the following wind loads

Stud Spacing (mm)	Maximum Bradford Plasti-Grip Washer Spacing (mm)								
	Ultimate Design Wind Pressure (kPa)								
	0.50	0.75	1.00	1.25	1.50	1.75	2.00	2.25	2.50
300	300	300	300	300	300	300	300	300	300
400	300	300	300	300	300	300	250	250	200
450	300	300	300	300	300	250	250	200	200
600	300	300	300	300	250	200	-	-	-

Note: Screw fixings for attaching washers to timber or steel framing shall be a minimum 8g self-drilling screws. Screws into timber shall have a minimum 25mm embedment.

07

INSTALLATION

07

INSTALLATION



Check quality and quantity of panels and components before installing. If there is any sign of damage or visible defects in panels, or the colour/finish is not in keeping with the owners aesthetic requirements **DO NOT INSTALL.** Contact Cemintel to address any issues.

CHECKLIST – Prior to Installation

The following pre-install checklist may assist to ensure you have the best possible outcome when using Cemintel Territory.

- Ensure substrate is straight and plumb. Pack studs to straighten if necessary (timber frames as per AS 1684, steel frames as per AS/NZS 4600) industry best practice for frame tolerance is 5mm misalignment over 3000mm.
- Ensure studs are correctly located and of the appropriate thickness.
- Confirm bracing is in place. Where sheet bracing is used behind panels, the entire wall area needs to be braced or bracing sheet packers fixed to the frame to ensure a uniform fixing plane.
- Remove any concrete that may foul the cladding line, particularly at steps in slabs and isolated columns.
- Ensure there is adequate ground clearance to the bottom edge of the Territory panels as per regulatory requirements (including for water/rain runoff and termite management). These can vary from 50-150mm depending on type of ground and termite requirements.
- Confirm your panel layout to determine the location of joints and identify where additional studs are required at all short edge joints and internal and external corners.
 - If using pre-formed corners, studs need to be located to allow fastening of corner clips to support the corners.
 - Additional studs or blocking may be required for support and fixing of Territory joint backing strips at corners and junctions.
 - To allow for replacement of panels, a vertical break is recommended every 7 metres.
- Flashings, membranes and air barrier should be correctly installed, overlapped and taped at joints, prior to fixing panels. In the case of fixing to masonry, the top hats should be installed correctly. (Wall wrap/sarking is not required.)
- Install windows so that the back of the front face of the window (or any other protrusions including doors or meter boxes) will be flush with the face of the panels.
- Where there is no space to use a mounting clip along the bottom and top edge of the window, tack a horizontal green spacer to provide a firm surface for the cladding panel to maintain its position.
- Fit Head flashings over windows, doors and other penetrations.
- Confirm the chosen eaves/soffit details and prepare accordingly.
- Consider the need for structural support for fixtures such as pergolas and decking. No loads may be carried by the cladding.
- Confirm membranes and flashings for deck areas have been installed in accordance with manufacturers' specifications.
- Arrange for a pre-cladding inspection by the appropriate local building authority if required.



Installation Set-Out

Timber Framing

Timber framing must be in accordance with AS 1684 – Residential Timber-Framed Construction.

Standard framing techniques are appropriate for the horizontal panel system with the addition of double studs at all vertical panel joints to allow for fixing clips each side of the panel joint.

FIGURE 7.01 Typical Framing Set-Out with 90mm Timber Framing and Territory Pre-formed Corners – Plan View

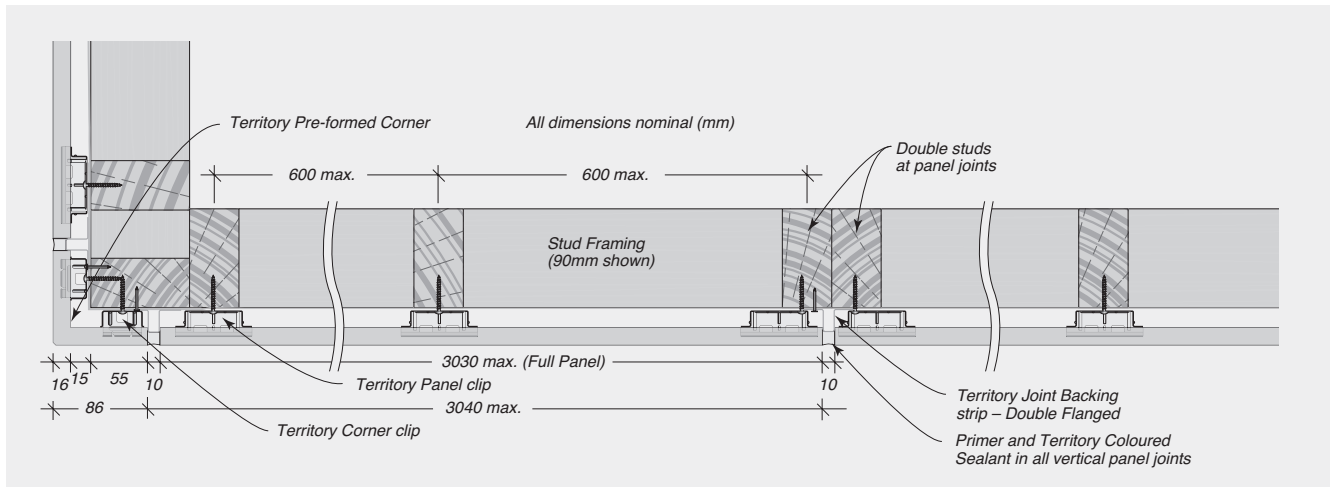
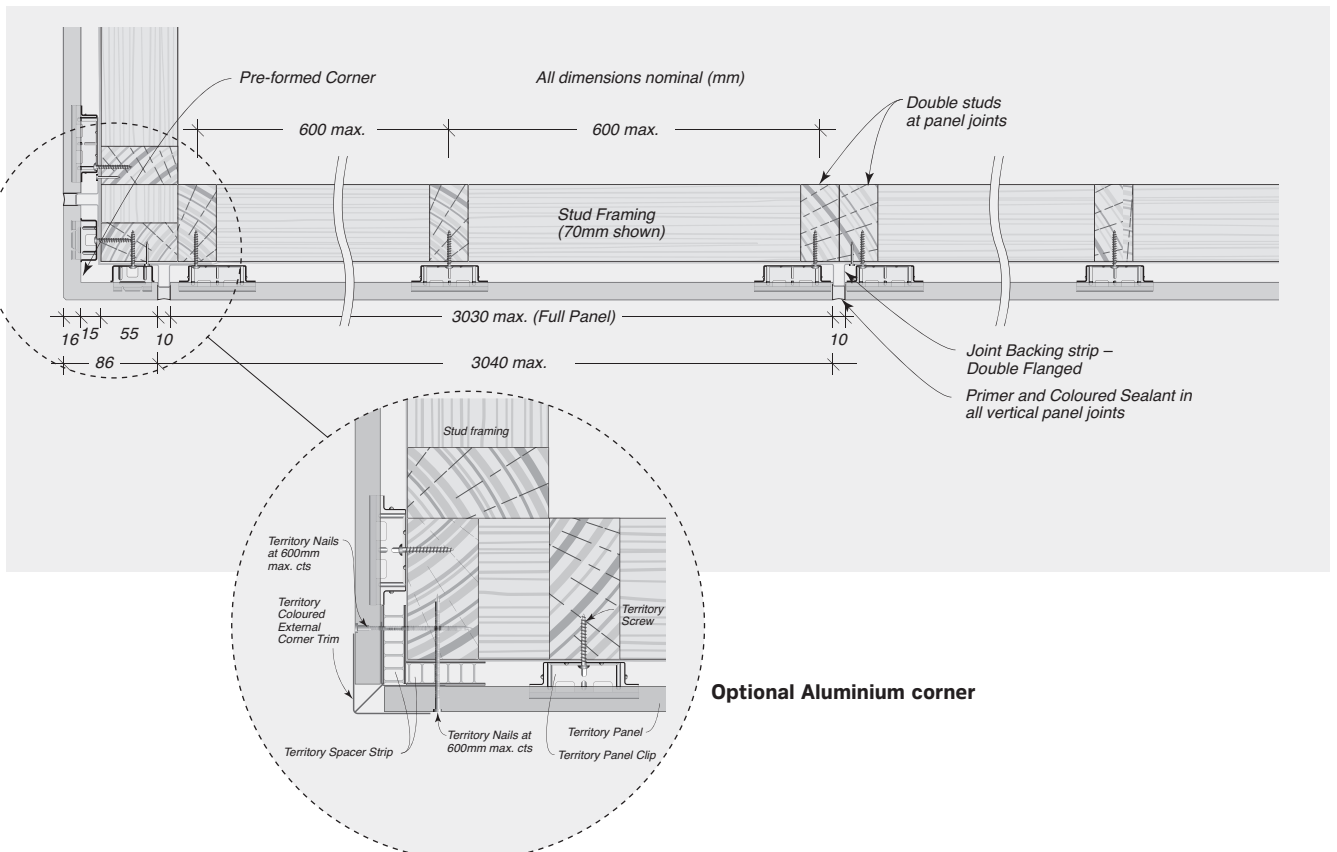

FIGURE 7.02 Typical Framing Set-Out with 70mm Timber Framing and Territory Pre-formed Corners – Plan View



07

INSTALLATION

FIGURE 7.03 Typical Territory System Cross Section for Timber Framing - Elevation

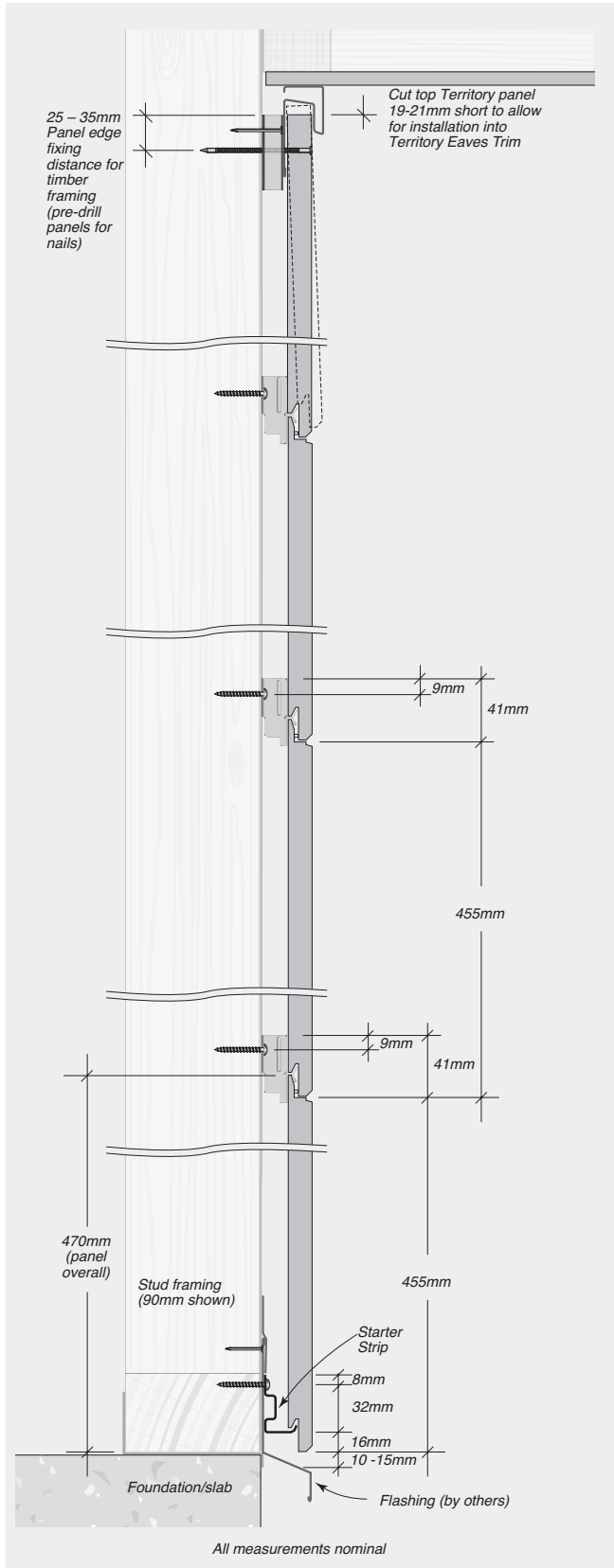
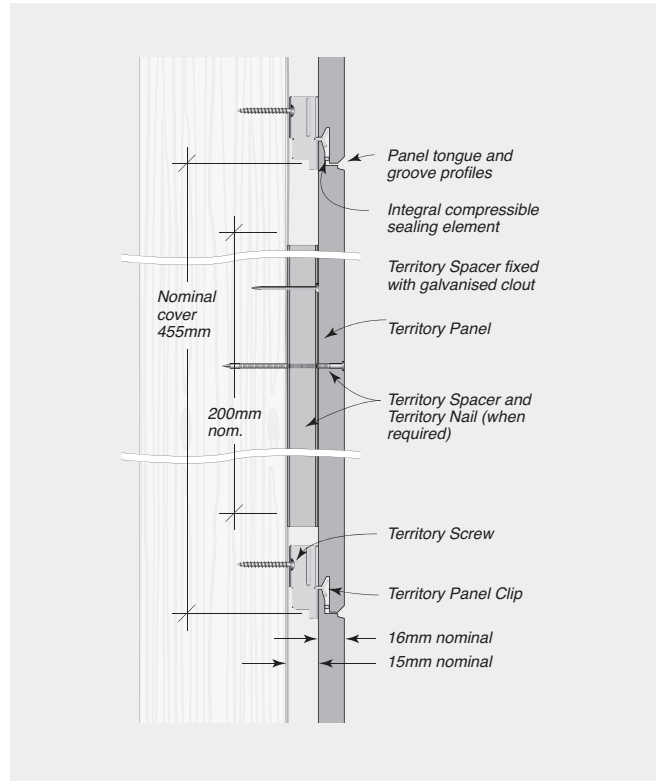

FIGURE 7.04 Typical Territory System Cross Section for Timber Framing for when face fixing is required - Elevation



Steel Framing

Steel framing must be in accordance with AS/NZ4600 – Cold Framed Steel Structures.

FIGURE 7.05 Typical Framing Set-Out with 90mm Steel Framing and Territory Pre-formed Corners – Plan View

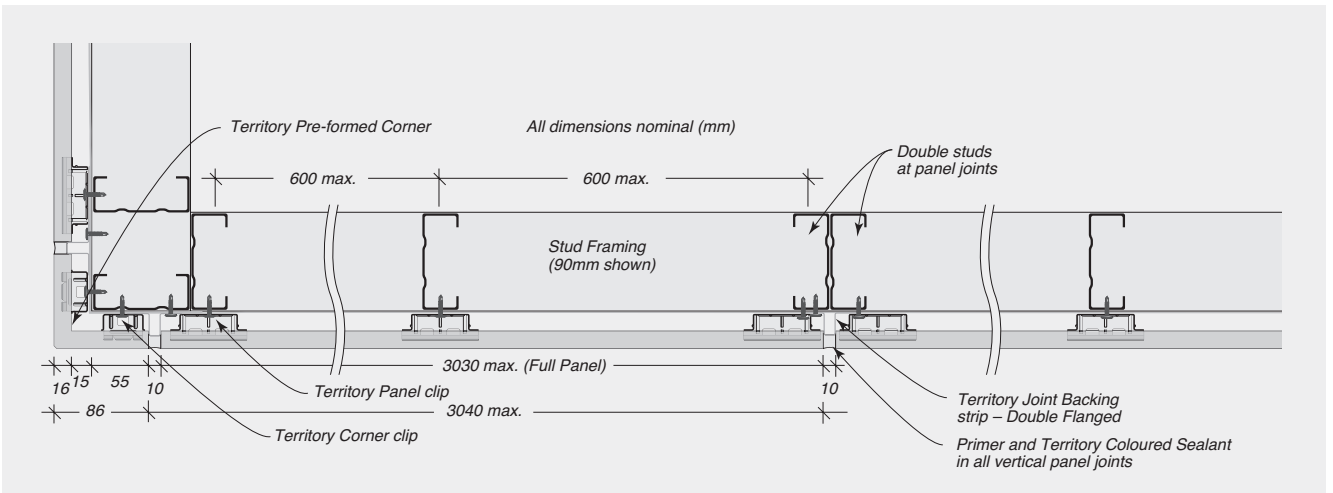
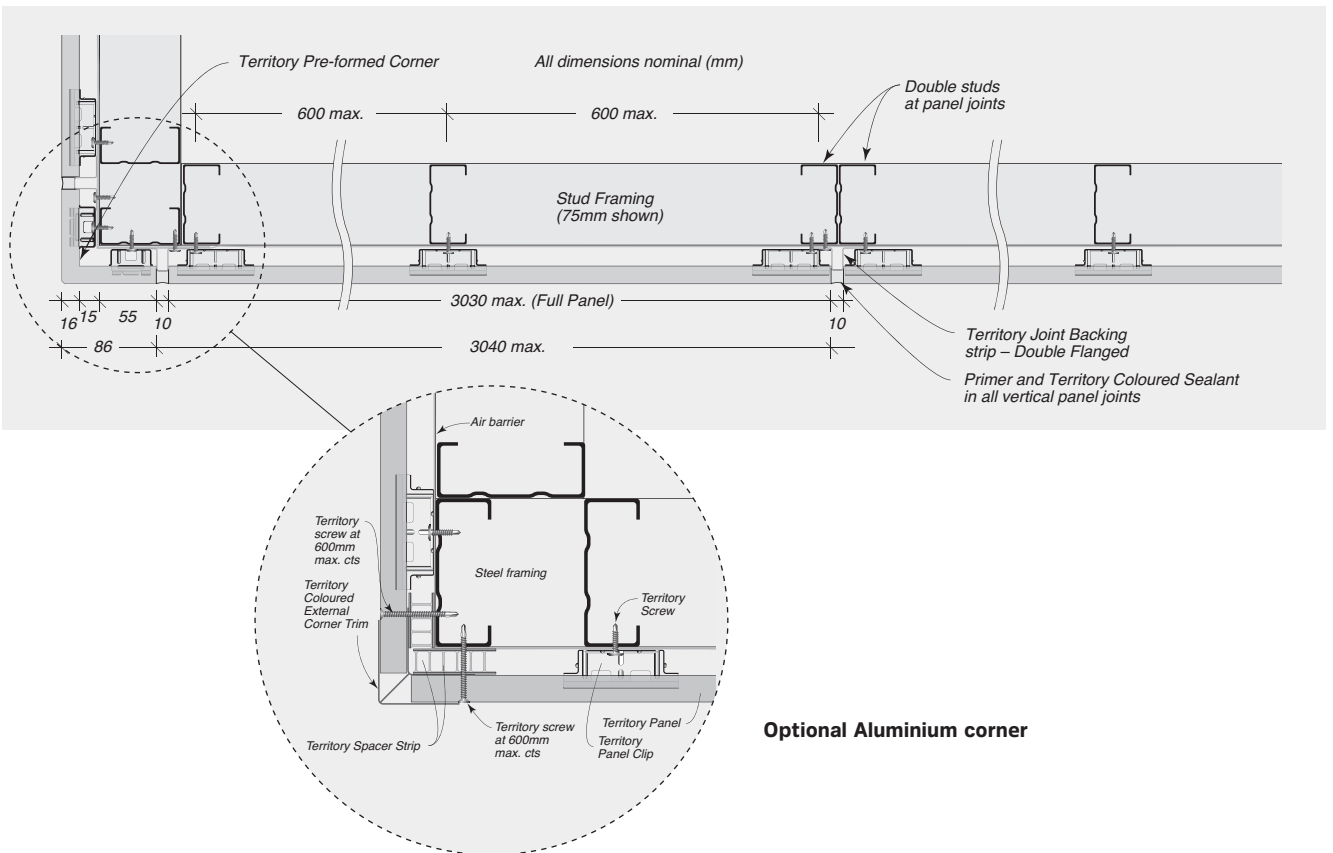

FIGURE 7.06 Typical Framing Set-Out with 75mm Steel Framing and Territory Pre-formed Corners – Plan View



Optional Aluminium corner

07

INSTALLATION

FIGURE 7.07 Typical Territory System Cross Section for Steel Framing - Elevation

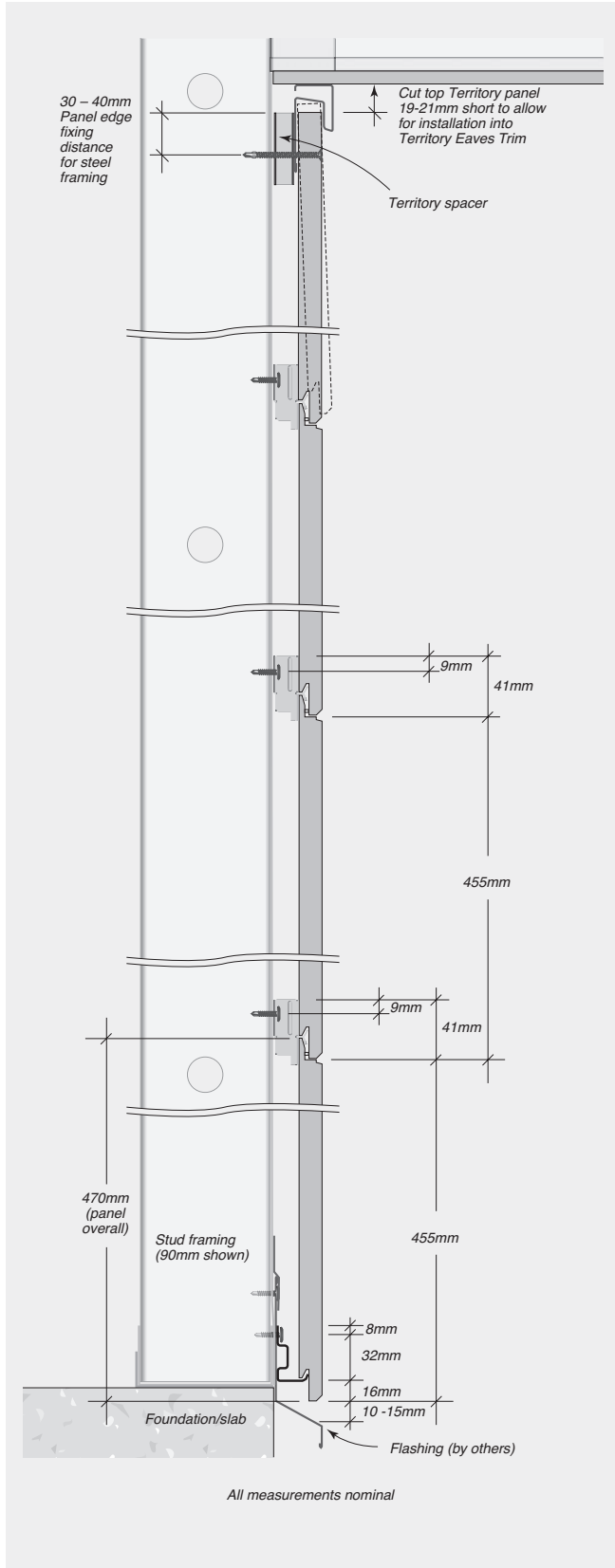
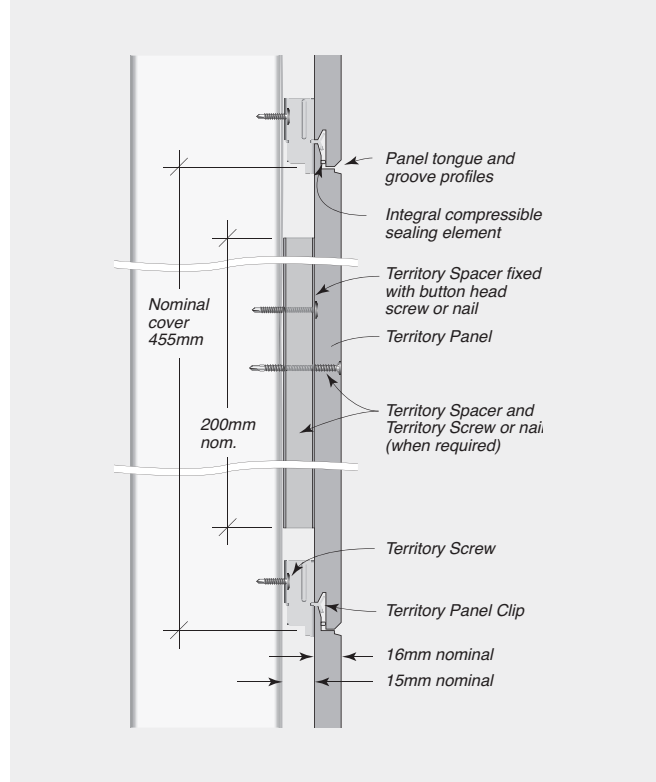

FIGURE 7.08 Typical Territory System Cross Sectional Detail for Steel Framing where Face Fixing is required - Elevation



INSTALLATION



Masonry

FIGURE 7.09 Typical Set-Out with H515 Top Hat Framing and Territory Aluminium Corners – Plan View

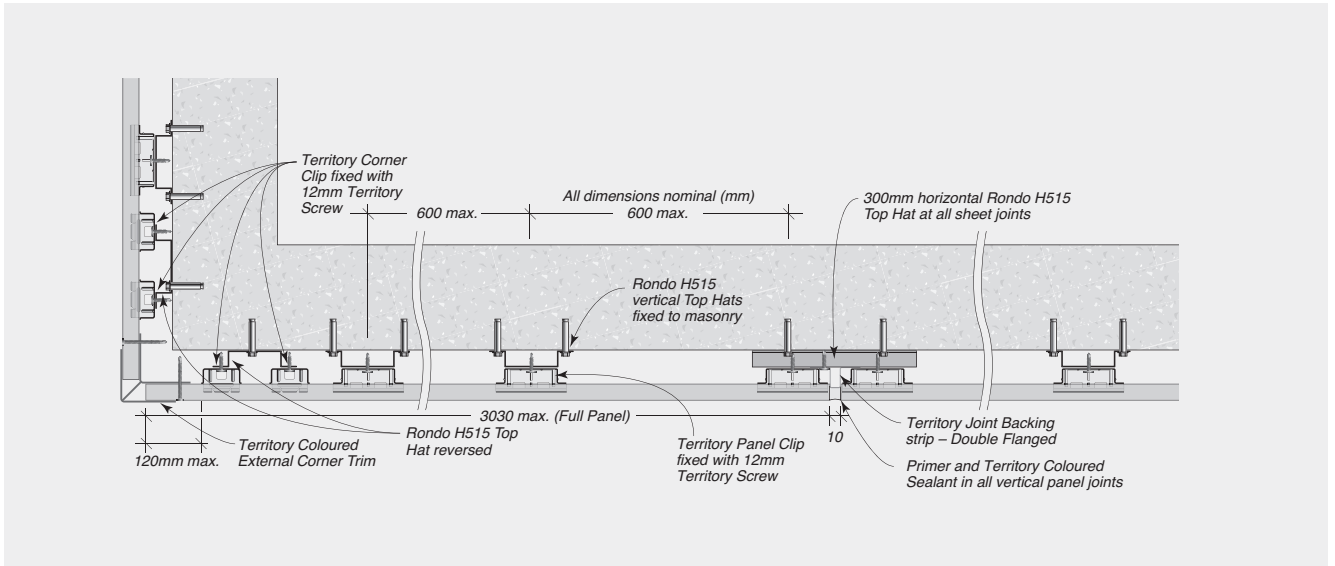

07

INSTALLATION

Masonry Framing

FIGURE 7.10 Typical Masonry Territory System Cross Section – Elevation

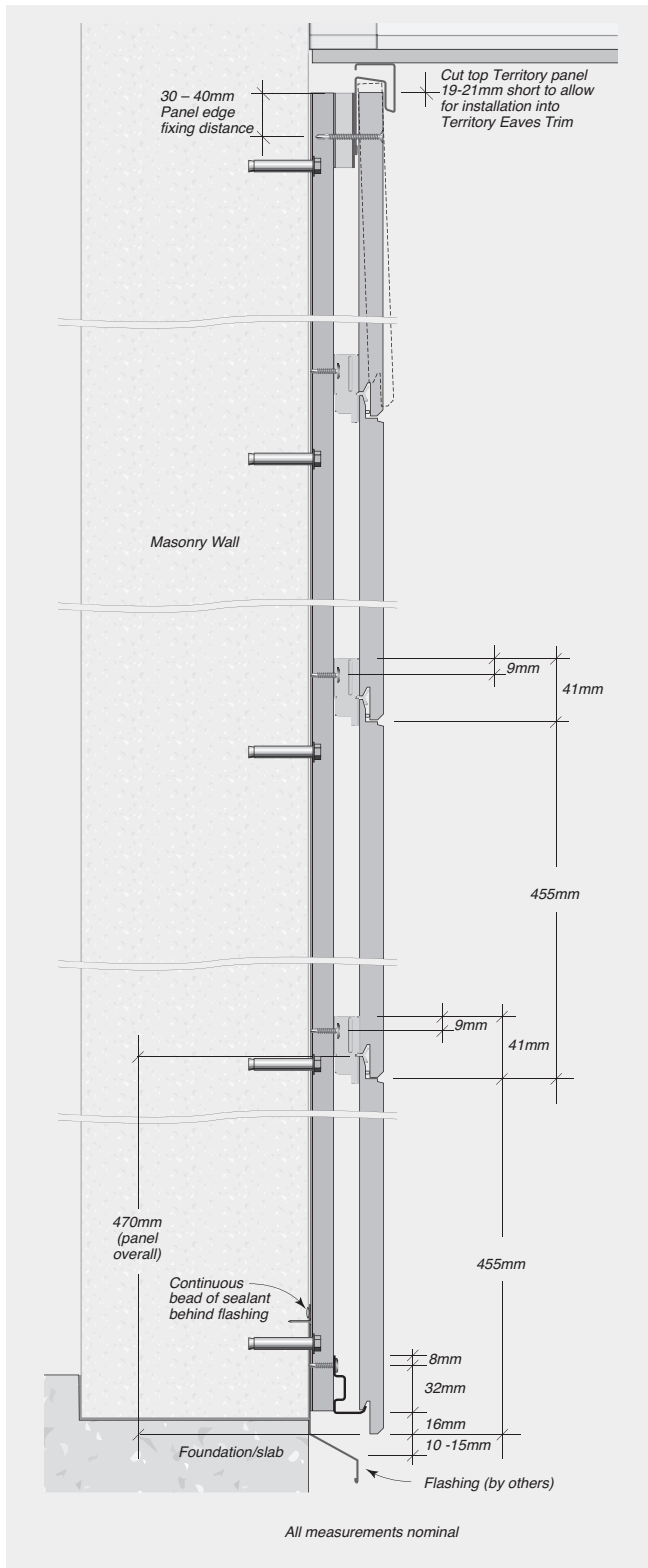

FIGURE 7.11 Typical Territory System Cross Sectional Detail for Masonry substrate where face fixing is required – Elevation

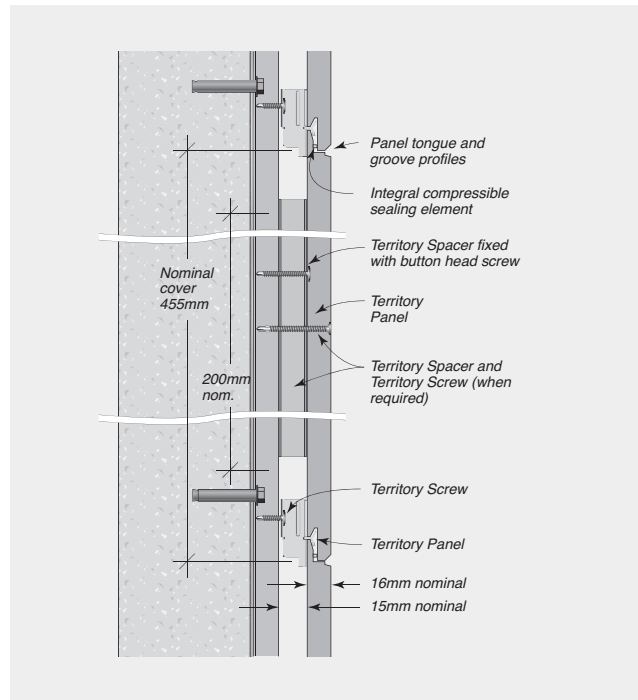
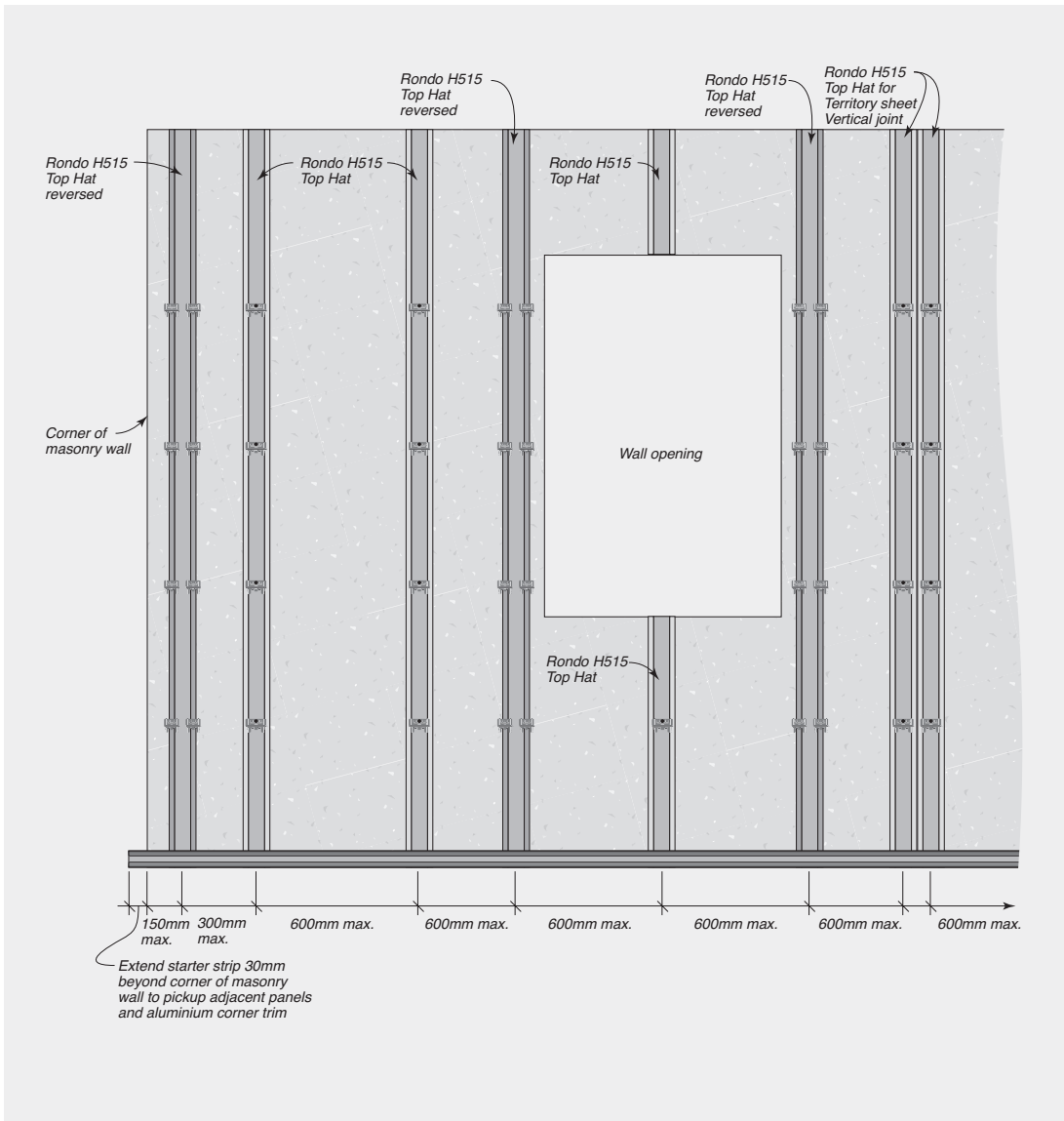

FIGURE 7.12 Masonry Overview Detail



Installation for Timber and Steel Framing

Refer to 'System Engineering' and 'Construction Drawings and Details' sections for specific fixing information.

Installation of Wall Wrap

This section outlines the typical installation of sarking/wall wrap. When an 'air seal' performance is required CSR recommends installation of a rigid air barrier or soft air barrier, refer to Cemintel Rigid Air Barrier Design & Installation Guide and Cemintel Facades & Cladding Design Guide, respectively.

- A** Fix wall wrap to outside face of wall framing using double sided tape, staples or other approved methods (refer to manufacturer's instructions). If the membrane is used to provide a continuous air tight layer, all overlaps and penetrations should be sealed with tape.
- B** Vertical laps (including corners) should overlap by one stud spacing minimum and should be staggered between adjacent layers.
- C** Upper layers should overlap lower layers by 150mm minimum to ensure that water is always shed towards the outside of the membrane and building.
- D** Horizontal flashings such as at the head of doors and windows, horizontal storey junctions and at the wall base (when used) must be taped to the wall wrap to ensure water is always shed towards the outside.

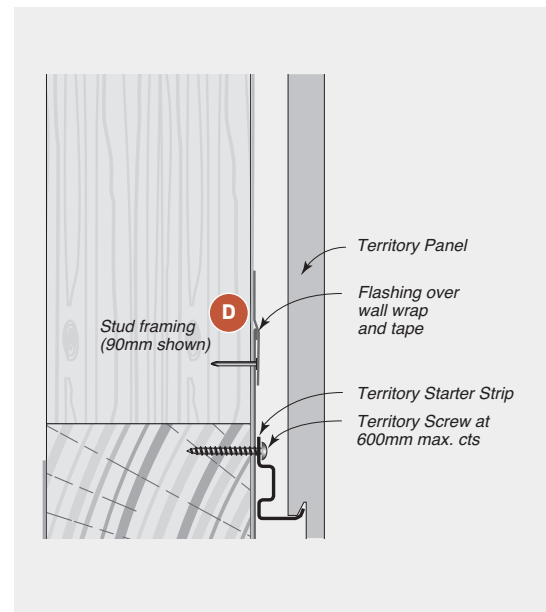
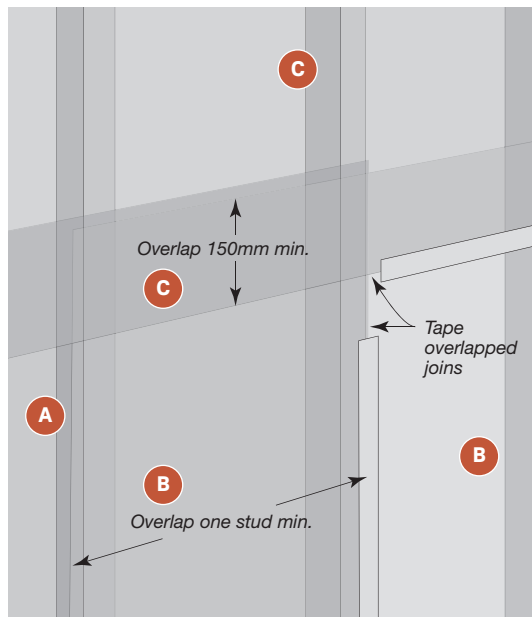

INSTALLATION

07

E At openings, slit the wall wrap at 45 degrees from each corner to the centreline. Slit the centreline to open the wrap.

F Wrap the tabs around the framing.

G Fix wall wrap to the rear of the framing with staples at 300mm maximum centres.

H Apply Wall Wrap tape to the corners of openings.

I Wipe tape over the frame edge onto the face of the wall wrap.

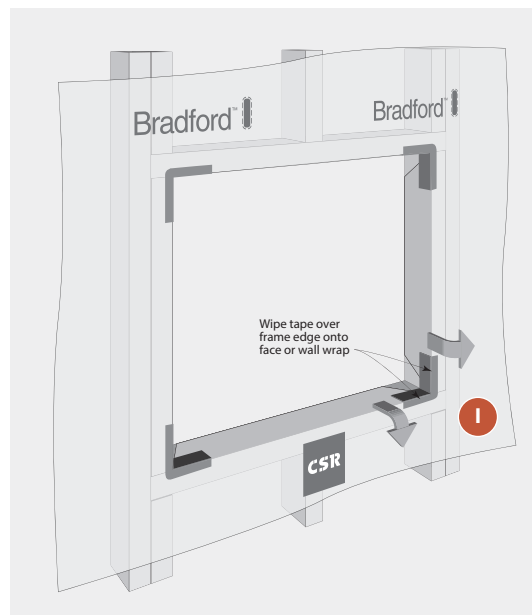
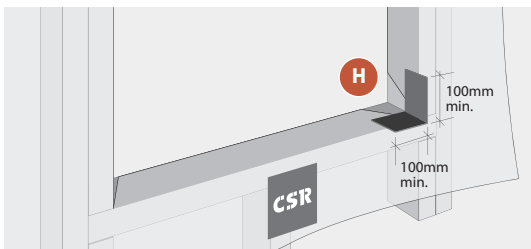
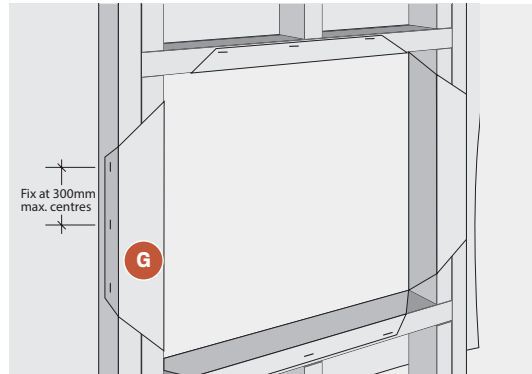
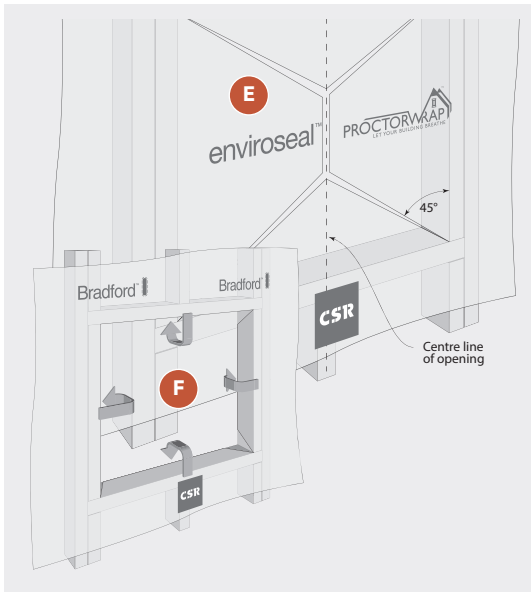

Installation of Territory Panels

Refer to 'System Engineering' and 'Construction Drawings and Details' sections for specific fixing information.

Step 1 – Fix base flashing to base of wall over air barrier (wrap/sarking or Rigid Air Barrier), taping top edge of flashing to Air Barrier.

Step 2 – Install horizontal starter strip to the base of the wall. Find the lowest point of the flashing where you will be installing your panelling and measure up 26mm from this point. 16mm is the overhang of the panel when it sits on the starter strip, and the first row of panels needs to be positioned to clear the flashings by 10-15mm (or in the case of working from ground level, to the minimum height the local building regulations specify).

Fasten the starter strip level along the whole length of the strip to the base plate/studs. Because each panel sits on top of the other, any errors in setting the level on the first wall panel will be compounded through each layer. It is therefore critical to ensure the starter strip is fitted level, ready to accept the first panel.

Step 3 – Install joint backing strips

Install joint backing strips at all vertical joint locations.

Step 4 – Install corners

- A.** If installing prefinished corners, slide the first corner piece down the corner and over the starter strip. Then insert the narrow corner clip on each side and screw to the stud. It is important to ensure that each corner piece is square on both sides. If the corners are not square, pack out the clips. To add the next corner piece, slide it on top so that it sits firmly on the clips and tap into position. Secure another set of clips to the top of the corner and screw fix to framing.
- B.** If installing aluminium corners, cut to length remembering to deduct the height measurement of the eaves trim. Notch out to extend over the starter strip. To maintain the 15mm cavity, first tack vertical spacers on each side of the corner stud. Allow a small amount of space at the top to allow for ventilation. Fix the eaves corner piece. Then, ensuring the aluminium corner trim is level, nail or screw it through the spacer to the frame. The wall panel should fit into the corner trim channel and slide down onto the starter strip.

Step 4 – Install wall panels. When cutting panels it is important that any cut edges are sealed with Cemintel's recommended edge sealant to protect against moisture entering the panels.

Place the first wall panel over the starter bar and slide into place. Position horizontal panel clips firmly over panels at every stud and screw into place. Pack out the clips if necessary to ensure a uniform fixing plane. We recommend consulting the local building surveyor regarding appropriate materials for packing.

Where face fixing may be required, a strip of Spacer (cut to a minimum length of 200mm) should be positioned between the panel and the frame, thus maintaining the 15mm cavity.

Step 5 – Finishing at the soffit. Fix a strip of spacer (or cut to a minimum length of 200mm at each stud) below the eaves or soffit to maintain the 15 mm cavity.

Slide the eaves trim into the eaves corner piece. Install the eaves trim hard against the eaves or soffit and fix through the spacer onto each stud. In the case of a backing strip being located on a stud, notch the back of the eaves trim so as to fit over the backing strip.

Cut the top panel/prefinished corner 5-10mm shorter than the height inside of the eaves trim to allow lifting of the final panel and dropping into place. Mark the position of the studs to identify fastening points. Predrill panels. Fasteners should be located 20-35mm from panel edges for timber frames or 30-40mm for steel frames.

Tilt the panel out at the bottom and insert the top edge of the panel into the eaves trim. Lift panel up and locate the bottom edge of the panel onto the clips already installed. Once firmly in place, nail panels to the studs using the Cemintel supplied face fix nails.

Step 6 – Caulk all expansion joints. Apply masking tape to each side of the vertical joints and at the base. Paint the edges of the panels with the primer. This helps the sealant adhere to the panels. Wait at least 30 minutes but no more than 6 hours to apply the sealant. Smooth off the finish removing excess sealant. Carefully remove masking tape in accordance with manufacturer's instructions. CARE NEEDS TO BE TAKEN NOT TO GET SEALANT ON PANELS as this can result in marks and stains.

Install sealant to gaps at windows and other penetrations.

Step 7 - Touch up any exposed fasteners.

Wipe panels down with a damp cloth and touch up any exposed nail or screw heads with matching touch up paint.

INSTALLATION

07

- 1 Air barrier
- 2 Base flashing
- 3 Horizontal starter strip
- 4 Face fixings (if required) using spacer
- 5 Joint backing strip (double flange)
- 6 Pre-formed horizontal corner
- 7 Corner clip
- 8 Horizontal panel clip
- 9 Face fixing (if required)
- 10 Horizontal Spacer
- 11 Eaves trim
- 12 Face fixings using spacer

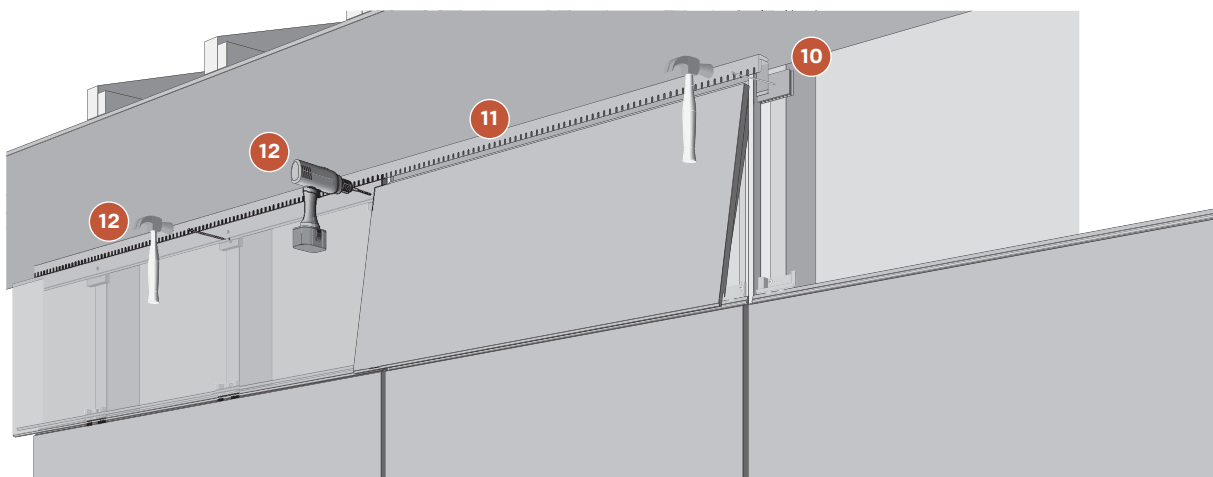
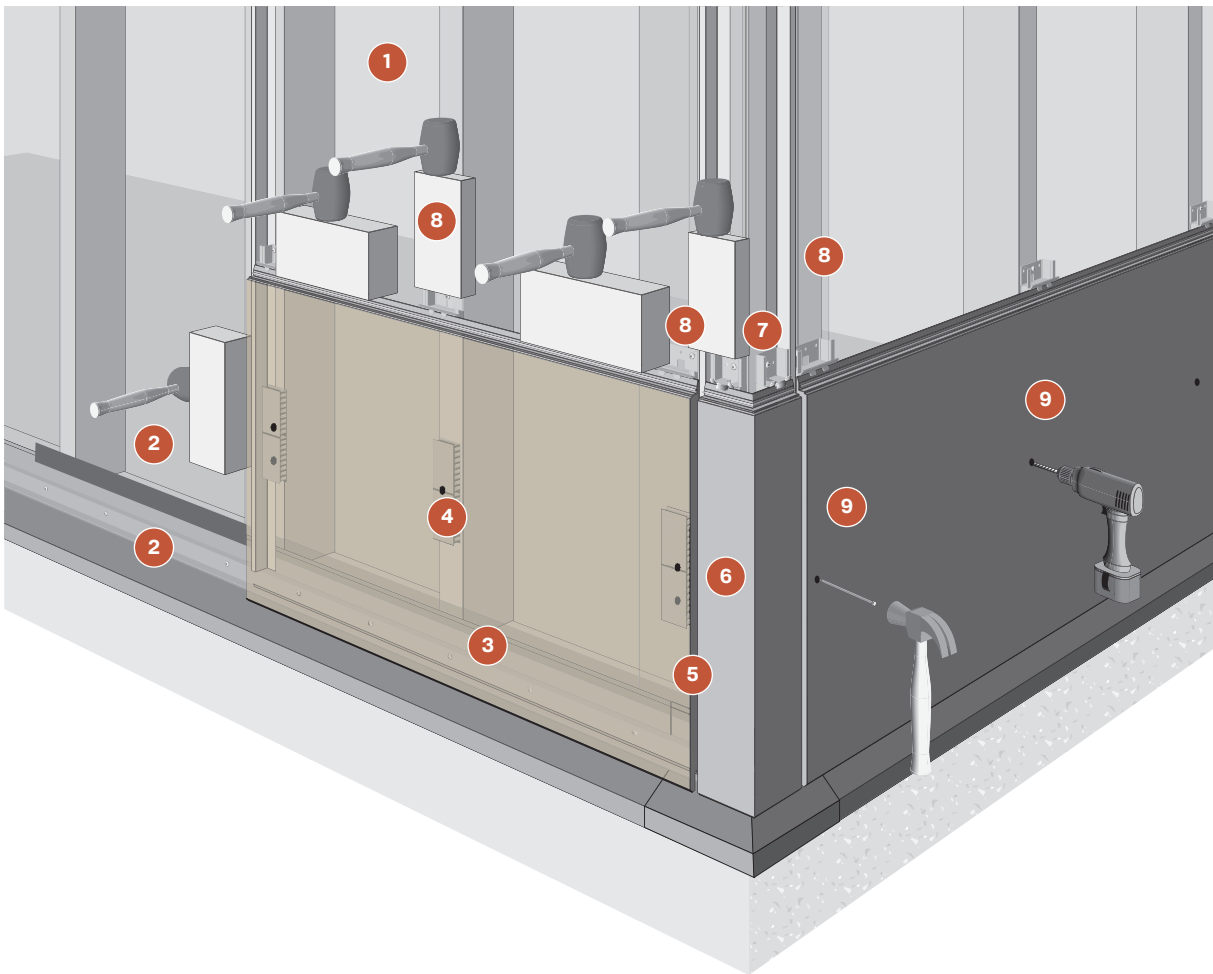

Installation for Masonry

Refer to 'System Engineering' and 'Construction Drawings and Details' sections for specific fixing information.

Note that masonry structures are potentially more likely to be out of plumb. The Top Hat installation detailed in this Guide only allows for a small variation in the surface plane and industry best practice for frame tolerances of 5mm misalignment over 3000mm should be followed. Careful assessment should be undertaken to determine if this solution is appropriate for the specific situation.

Metal corners are recommended when installing onto masonry.

Step 1 – Fix base flashing to base of wall with a continuous bead of sealant behind the flashing. Note: other flashings must also be installed prior to installation of H515 Top Hats.

Step 2 – Install H515 Top Hats vertically at maximum 600mm centres. To account for minimum edge distance of masonry fixings, install Top Hats in reverse at corners and openings.

Step 3 – Install the starter strip to the base of the wall, screw fixing at each Top Hat. Make allowance for 16mm panel overhang. Ensure 10-15mm clearance between base flashing and bottom edge of panel. Starter strip needs to be extended 30mm beyond the end of the wall to accommodate the cavity (H515 and clips).

Step 4 – Install joint backing strips. Install joint backing strips at all vertical joint locations.

Step 5 – Install wall panels. Cut panel as required and seal any cut edges with Cemintel edge sealer. Install first panel, firmly tapping panel onto the starter strip. Check level and ensure a uniform fixing plane. Install panel clips to the edge of the panel, firmly tap into place and screw fix at each H515 Top Hat.

Where face fixing may be required, a strip of Spacer (cut to a minimum length of 200mm) is to be positioned between the panel and the Top Hat frame, thus maintaining the 15mm ventilated cavity.

Fasteners should be located 30-40mm from panel edge.

Repeat the above steps for additional rows of panels.

Step 6 – Finishing at the soffit. Fastener fix a strip of spacer on each H515 Top Hat below the Eave or Soffit to maintain the 15mm cavity. Slide the eaves trim into the eaves corner piece. Install the eaves trim hard against eave or soffit and fix through the spacer at each H515 Top Hat. In the case of a backing strip, notch the back of the Eave Trim so as to fit over the backing strip.

Cut the top panel/prefinished corner 5-10mm shorter than the height inside of the eaves trim to allow lifting of the final panel and dropping into place. Tilt the panel out at the bottom and insert the top edge of the panel into the eave trim. Lift panel up and locate the bottom edge of the panel onto the clips already installed. Once firmly in place, face fix the top of the panel with fasteners through the spacer strips at each Top Hat, 30-40mm from panel edges.

Step 7 – Install metal external corners. Once panels are installed along one wall, slide aluminium corner into position and fix using 45mm screw. Proceed to install panels along adjacent wall. Note that when cutting corners to length remember to deduct the height measurement of the eave trim.

Step 8 – Caulk all expansion joints. Apply masking tape to each side of the vertical joints and at the base. Paint the edges of the panels with the primer. This helps the sealant adhere to the panels. Wait at least 30 minutes but no more than 6 hours to apply the coloured sealant. Smooth off the finish removing excess sealant. Carefully remove masking tape in accordance with manufacturer's instructions. CARE NEEDS TO BE TAKEN NOT TO GET SEALANT ON PANELS as this can result in marks and stains.

Install sealant to gaps at windows and other penetrations.

Step 9 – Touch up any exposed fasteners. Apply a metal primer and touch up paint to all visible fastener heads.

INSTALLATION

07

Installation of Cemintel Rigid Air Barrier™

The Cemintel Rigid Air Barrier may be installed horizontally or vertically across the frame. An appropriate panel fixing layout should be selected for the project design wind pressure and frame spacing. Panels must be fixed in accordance with the tables set out in the Cemintel Rigid Air Barrier Design & Installation Guide.

Panels are fixed to timber framing using nails to steel framing using screws. A small joint (maximum 3mm) is acceptable. Joints are taped using HighTack tape to form an air barrier. Similarly, all corners, penetrations and junctions are sealed with HighTack tape or with flexible sealant.

All flashings should be fixed over the top of the Rigid Air Barrier and taped with HighTack tape.



Check quality and quantity of panels and components before installing. If there is any sign of damage or visible defects in panels DO NOT INSTALL. Contact Cemintel to address any issues.

Procedure for Horizontal or Vertical Sheet Application

- 1 Cut sheets to ensure vertical joints are supported by studs and horizontal joints are backed by noggings.
- 2 Position sheets (refer to Head & Base details in 'Construction Details' section). Screw fix (to steel frame) or nail (to timber frame) at the detailed fastener centres.
- 3 Install adjacent sheets.
- 4 Seal vertical joints, horizontal joints, and corners with HighTack tape. Seal junctions and penetrations with Sikaflex Pro flexible sealant.
- 5 Seal any openings in head, sill and jamb framing with HighTack tape.
- 6 Apply SLS FlexiTape to corners of window and door openings.

FIGURE 7.01 Typical Rigid Air Barrier Installation

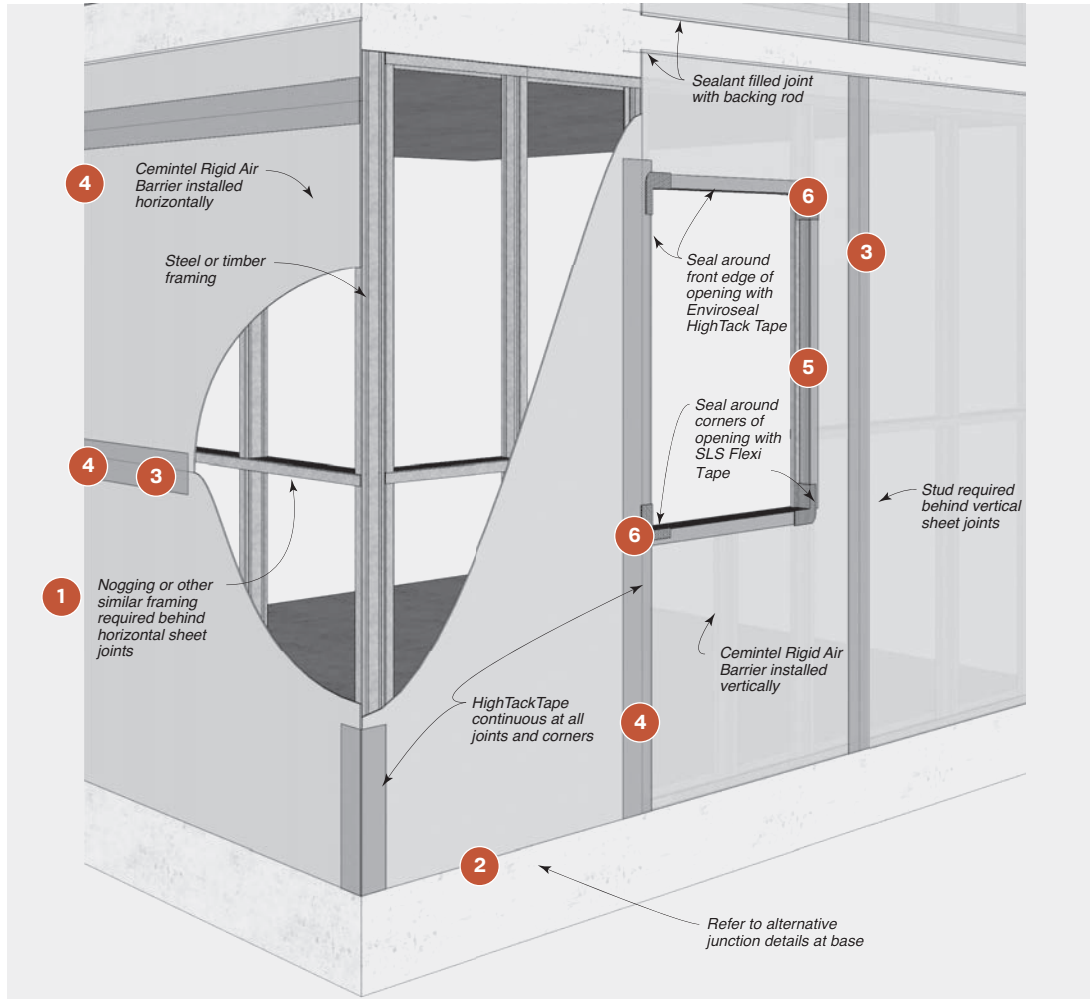

07

INSTALLATION

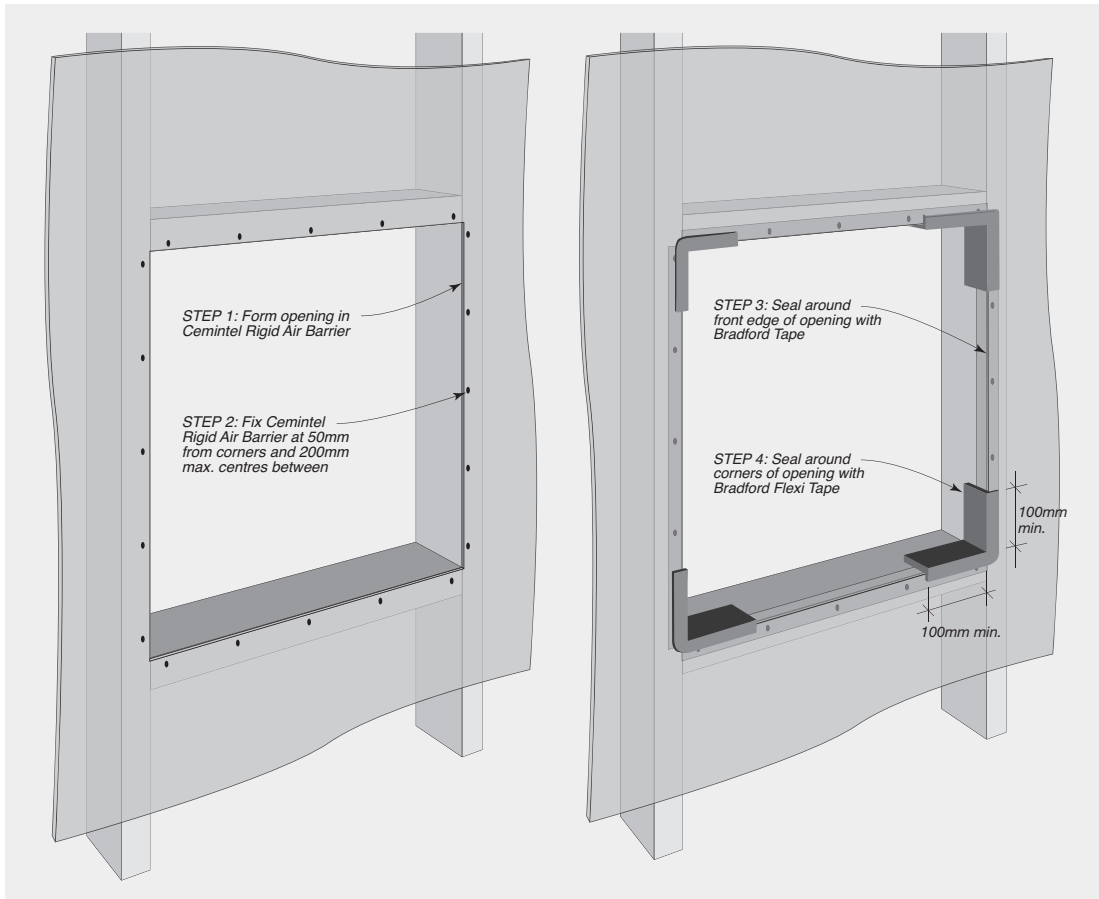
FIGURE 7.02 Treatment at Window/Door Openings - Rigid Air Barrier

Installation of Soft Air Barriers

Wall wraps intended to be used as air barriers are fixed to timber or steel framing. Enviroseal™ CW-IT has an inbuilt adhesive strip which allows fast, consistent and reliable sealing to adjoining rolls of CW-IT.

At internal corners, penetrations and perimeters of areas with wall wrap, a metal strip is required to restrain the wall wrap edges. The wall wrap is then

folded over and taped to the main body wrap with HighTack Tape. As detailed, sealant or tape is to be applied to maintain an effective air seal.

All flashings should be fixed over the top of the wall wrap and taped.

Procedure for Installation of Soft Air Barriers

- 1 Install wall wrap to outside face of timber or steel wall framing using Bradford Plasti-Grip Washers. Horizontal laps must be overlapped by 150mm.
- 2 Install minimum 20mm x 1.6mm aluminium strips horizontally at head and base of wall. Pass wall wrap under aluminium strip and fix strip at 100mm max. cts. Then fold wall wrap back over strip and tape with HighTack tape to main body.

FIGURE 7.03 Typical Soft Air Barrier Installation

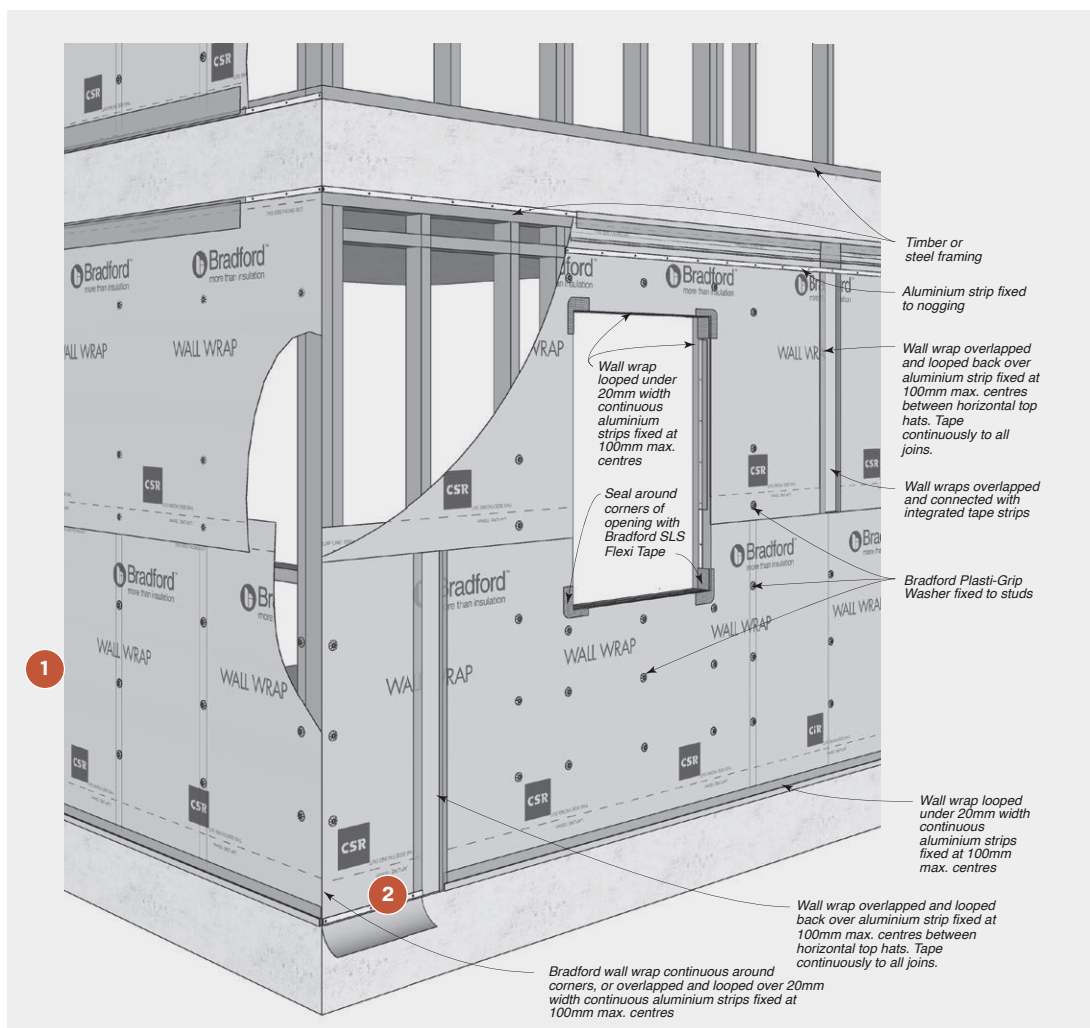

07

INSTALLATION

- 3 Install aluminium strips at vertical joints/ends/ corners (where required). Pass wall wrap under aluminium strip and fix at 100mm max cts. Fold wall wrap back over strip and tape with HighTack tape to main body.
- 4 Enviroseal™ CW-IT to be overlapped at horizontal joints and taped continuously with in-built adhesive strip. Vertical lap joints to be overlapped across adjoining studs, fixed with Bradford Plasti-Grip Washers, aluminium strips and taped with HighTack tape along overlap joint. (Refer to Table 4.03).
- 5 At openings, cut the wrap at 45 degrees from each corner to the centre.
- 6 Pass wall wrap under aluminium strip and fix at 100mm max. cts. Then fold wall wrap back over strip and tape with HighTack tape, cutting away any excess wall wrap.
- 7 Apply SLS Flexi Tape to the corners of window and door openings. Press tape over the frame edge onto the face of the wall wrap.

FIGURE 7.04 Treatment at Window/Door Openings - Soft Air Barrier

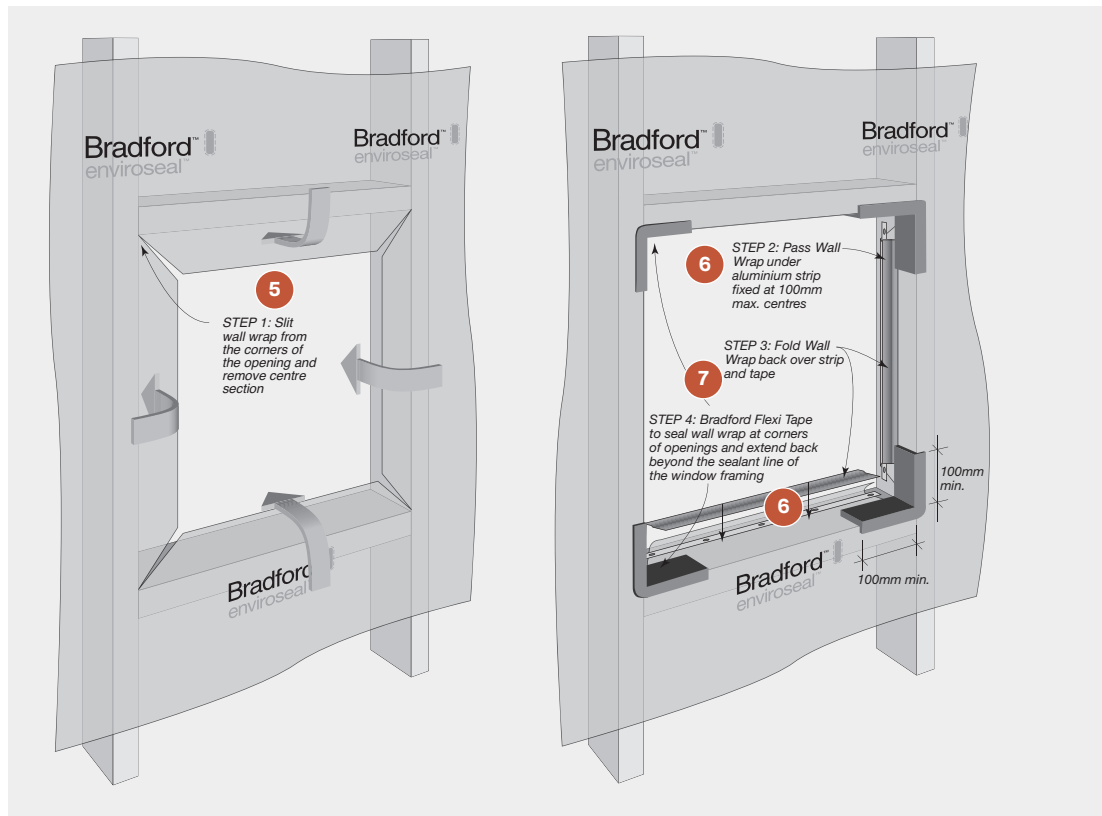



CONSTRUCTION
DRAWINGS + DETAILS



CONSTRUCTION DRAWINGS AND DETAILS

Note: Drawings are interchangeable for timber or steel substrates with the exception of the fasteners.

Drawings Index

SECTION	DESCRIPTION	FIGURE REFERENCE	PAGE NUMBER	
GENERAL				
Base Details	Base Detail – 90mm Framing	8.01	56	
	Base Detail – 70mm Framing	8.02	56	
	Second Storey Junction with Masonry, Brick Veneer or Hebel Panels – Cantilevered Framing	8.03	56	
	Second Storey Junction with Masonry, Brick Veneer or Hebel Panels – In-line Framing	8.04	56	
Corner Details	External Corner Detail – with Pre-formed Corner	8.05	57	
	External Corner Detail – with Aluminium External Corner	8.06	57	
	Internal Corner Detail – with Backing Strip and Coloured Sealant	8.07	57	
	Obtuse Angle Corner Detail – with Metal Flashing and Coloured Sealant	8.08	57	
Junction Details	Soffit Detail – with Coloured Eaves Trim	8.09	58	
	Soffit Detail – with L-form Cavity Vent and Timber Trim	8.10	58	
	Soffit Detail – with Soffit Trim	8.11	58	
	Horizontal Control Joint	8.12	58	
	Junction with External Pitched Roofing	8.13	59	
	Junction with External Flat Roofing	8.14	59	
	Junction with In-line Masonry Wall	8.15	59	
	Junction with Offset Masonry Wall	8.16	59	
	Junction – Flushed with Brick Veneer	8.17	60	
	Junction – Recessed with Brick Veneer	8.18	60	
	Typical Junction Detail with Fibre Cement Cladding System	8.19	60	
	Framing and Control Joint Detail at Edge Beam – Edge Beam height less than 450mm (Continuous Wall Wrap/Sarking Method)	8.20	61	
	Edge Beam Detail – Horizontal Top Hat	8.21	61	
	Window Details	A&L Aluminium Awning Window with Weatherboard Trim	8.22	62
		A&L Aluminium Siding Window with Weatherboard Trim	8.23	62
Trend 48mm Aluminium Awning Window		8.24	63	
Trend 48mm Aluminium Awning Window with Weatherboard Reveal Clip A327		8.25	63	
Trend Quantum XP Aluminium Sliding Window with Weatherboard Reveal Clip E482		8.26	64	
Typical Stegbar Window		8.27	64	
Window with Mitre Corners		8.28	65	
Window Reveal		8.29	65	
Generic Commercial Window		8.30	66	
Typical Window		8.31	66	
Door Details	Dowell Sliding Door Installation – 70mm Framing and 85mm Reveal	8.32	67	
	Typical Stegbar Sliding or Entry Door	8.33	67	
Parapet Details	Typical Parapet/Roof Junction	8.34	68	
	Parapet Wall	8.35	68	
	Parapet Wall Junction – Stage 1	8.36	69	
	Parapet Wall Junction – Stage 2	8.37	69	
	Parapet Wall Junction – Stage 3	8.38	70	
Balcony Details	Typical Balcony Detail	8.39	70	
Power/Meter Box Details	Typical Power/Meter Box – Mounted to Face of Framing	8.40	71	
	Typical Power/Meter Box – Recessed into Framing	8.41	71	

CONSTRUCTION DRAWINGS AND DETAILS



Note: Drawings are interchangeable for timber or steel substrates with the exception of the fasteners.

SECTION	DESCRIPTION	FIGURE REFERENCE	PAGE NUMBER	
GENERAL				
Masonry Details	Typical Base	8.42	72	
	External Corner Detail – with Aluminium External Corner	8.43	72	
	Internal Corner Detail – with Backing Strip and Coloured Sealant	8.44	72	
	Soffit Detail – with Coloured Eaves Trim	8.45	72	
	Masonry Junction Detail	8.46	73	
	Vertical Panel Joint (Option 1)	8.47	73	
	Vertical Panel Joint (Option 2)	8.48	73	
	Window Detail – A&L Aluminium Awning Window with Weatherboard Trim	8.49	74	
	Generic Commercial Window for Masonry Substrates	8.50	74	
	Typical Parapet/Roof Junction	8.51	75	
	Typical Power/Meter Box – Mounted to Face of Framing	8.52	75	
AS 5113 SPECIFIC				
Base Details	Base Detail	8.53	76	
Corner Details	External Corner Detail – with preformed Corner	8.54	76	
	Internal Corner Detail	8.55	76	
Junction Details	Junction with Masonry	8.56	77	
	Junction with Masonry Offset	8.57	77	
	Edge Beam Detail	8.58	78	
Window Details	Commercial Window Frame	8.59	78	
	Window Front Elevation	8.60	78	
Soffit Details	Interstorey Junction with Territory Ceiling	8.61	79	
	Territory Ceiling	8.62	79	
	Interstorey Junction with Metal Ceiling	8.63	80	
	Metal Ceiling	8.64	80	
	Interstorey Junction with Composite Ceiling	8.65	81	
	Composite Ceiling	8.66	81	
Parapet Details	Parapet Details – Horizontal Steel Framing	8.67	82	
Door Details	Dowell Sliding Door – Steel Framing	8.68	82	
SOFT AIR BARRIER				
Overview	Typical Installation Overview - Soft Air Barrier	8.69	83	
Corner Details	External Corner – Wall Wrap Continuous	8.70	84	
	External Corner – Wall Wrap Overlapped	8.71	84	
	Internal Corner – Wall Wrap Continuous	8.72	84	
	Internal Corner – Wall Wrap Overlapped	8.73	84	
	Junction Details	Abutment to Concrete or Masonry Wall	8.74	84
Junction Details	Wall Wrap Installation to Wall, Soffit and Base	8.75	85	
	Wall Wrap Installation at Intermediate Level Junction – Non-loadbearing Steel Framing With Deflection Head	8.76	85	
	Vertical Wall Wrap Junction – Overlapped Double Strip Join	8.77	86	
	Vertical Wall Wrap Junction – Overlapped Single Strip Join	8.88	86	
	Vertical Wall Wrap Junction – At Control Joint	8.89	86	
	Vertical Wall Wrap Junction – No Lap Double Washer	8.90	86	
	Window Details	Wall Wrap Installation at Window/Door Opening	8.91	87
	Junction Details	Wall Wrap Installation at Drain Penetration – Timber or Steel Framing	8.92	87
		Wall Wrap Installation at Parapet Junction – Timber or Steel Framing	8.93	88



CONSTRUCTION DRAWINGS AND DETAILS

Note: Drawings are interchangeable for timber or steel substrates with the exception of the fasteners.

GENERAL – Base Details

FIGURE 8.01 Base Detail – 90mm Framing

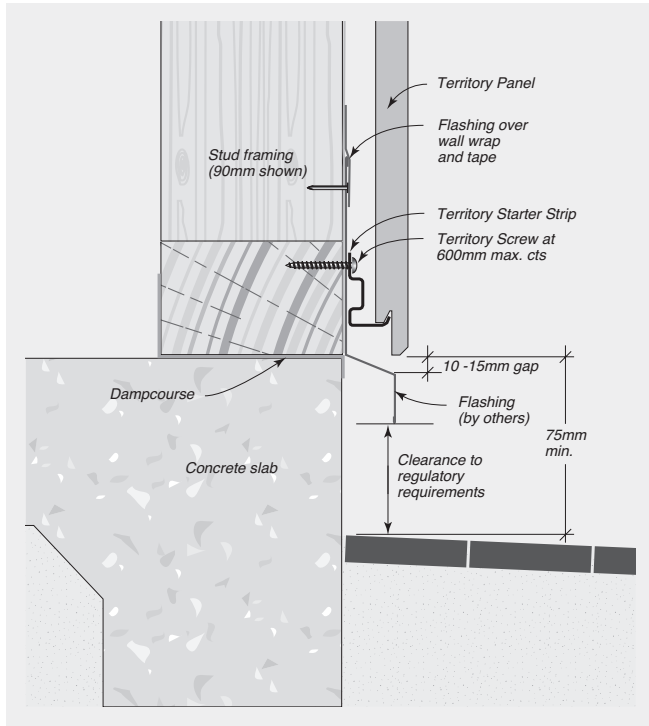

FIGURE 8.02 Base Detail – 70mm Framing

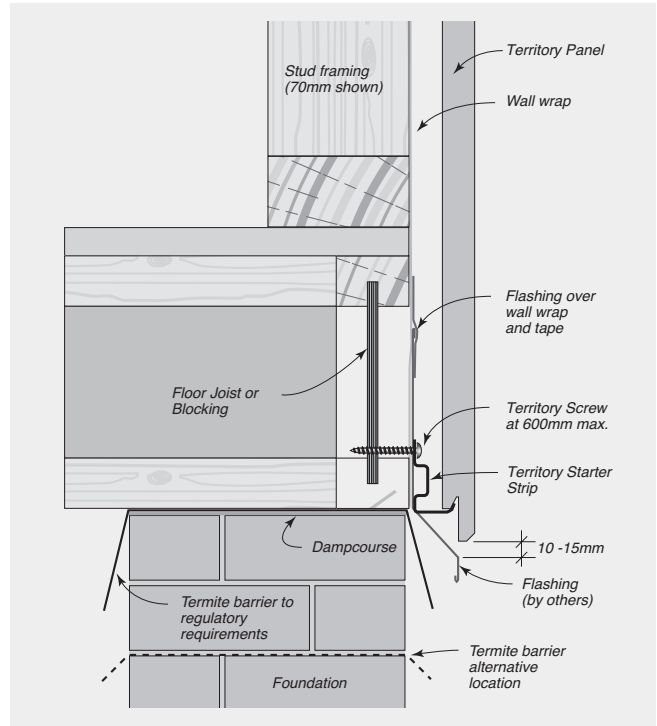

FIGURE 8.03 Second Storey Junction with Masonry, Brick Veneer or Hebel Panels – Cantilevered Framing

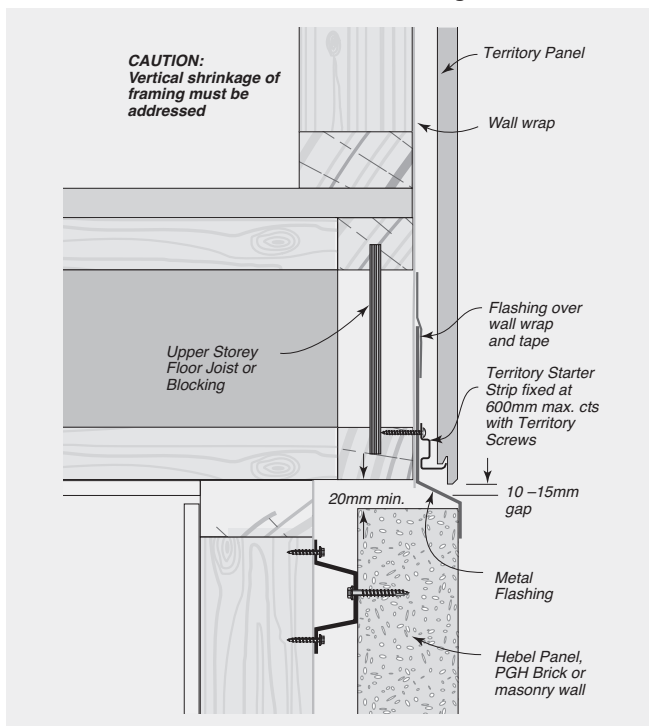
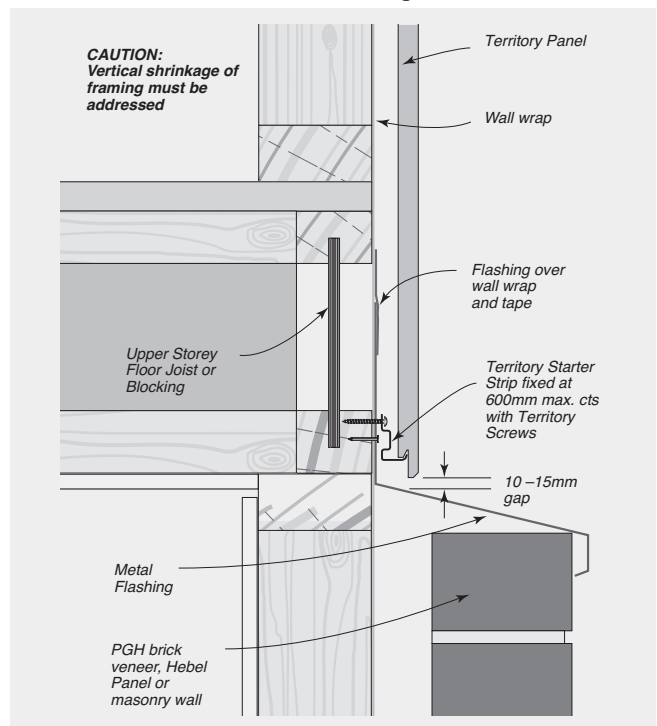

FIGURE 8.04 Second Storey Junction with Masonry, Brick Veneer or Hebel Panels – In-line Framing



CONSTRUCTION DRAWINGS AND DETAILS



Note: Drawings are interchangeable for timber or steel substrates with the exception of the fasteners.

GENERAL – Corner Details

FIGURE 8.05 External Corner Detail – With Preformed Corner

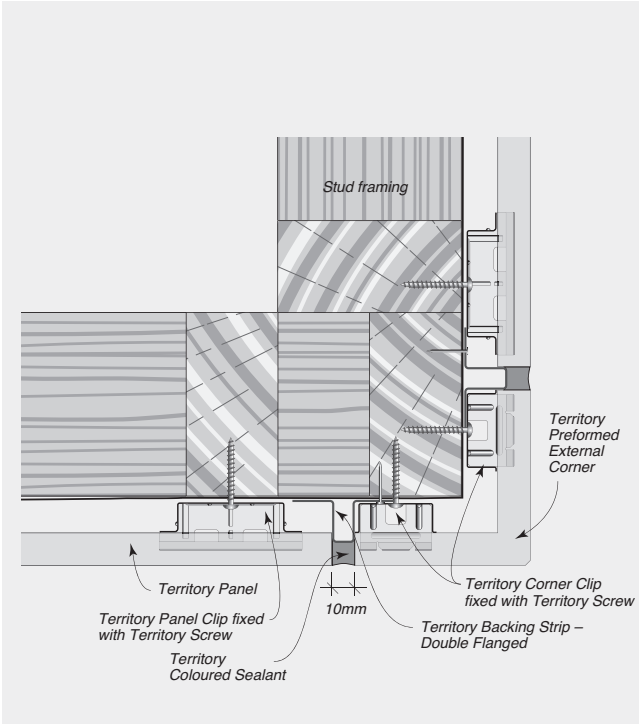

FIGURE 8.06 External Corner Detail – with Aluminium External Corner

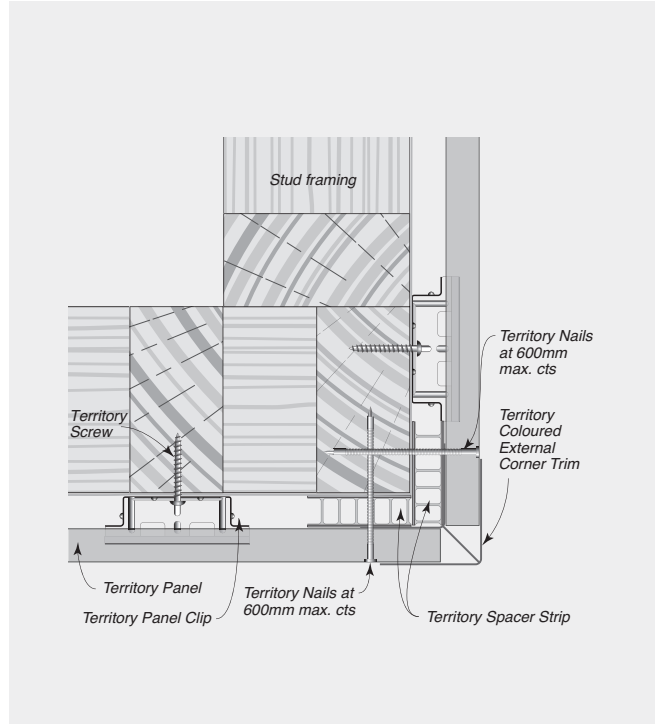

FIGURE 8.07 Internal Corner Detail – with Backing Strip and Coloured Sealant

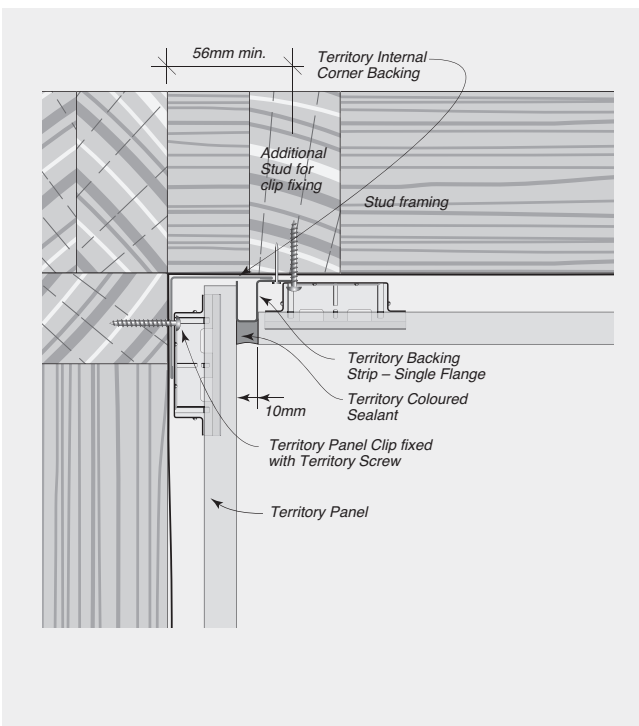
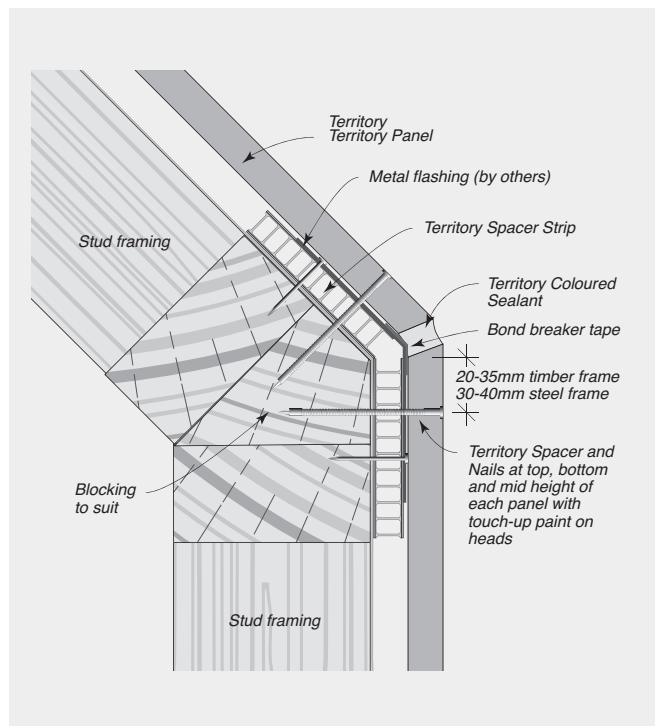

FIGURE 8.08 Obtuse Angle Corner Detail – with Metal Flashing and Coloured Sealant





CONSTRUCTION DRAWINGS AND DETAILS

Note: Drawings are interchangeable for timber or steel substrates with the exception of the fasteners.

GENERAL – Junction Details

FIGURE 8.09 Soffit Detail – with Coloured Eaves Trim

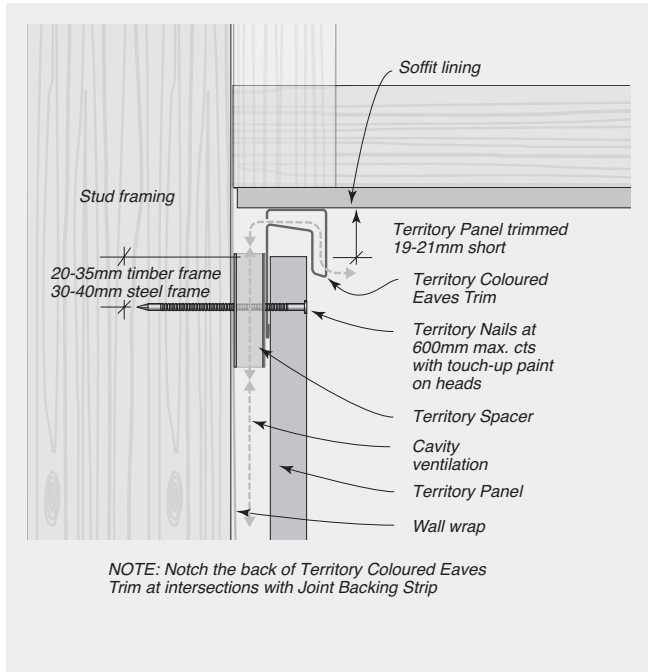

FIGURE 8.10 Soffit Detail – with L-form Cavity Vent and Timber Trim

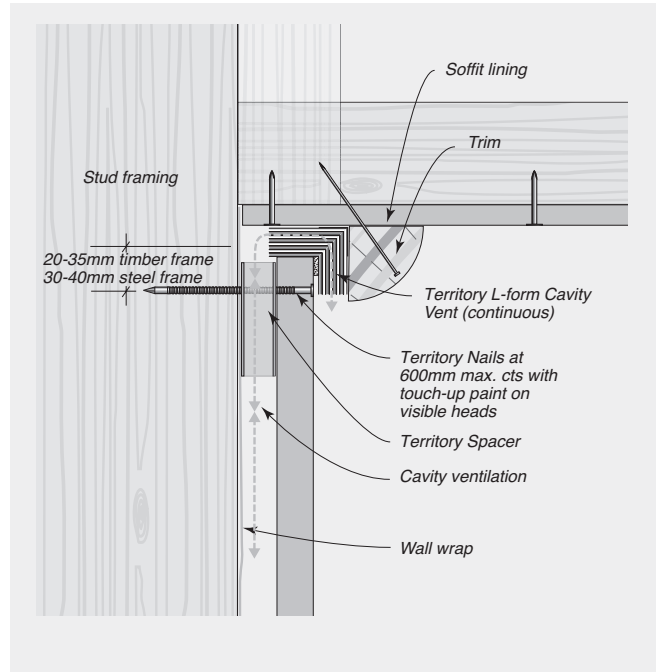

FIGURE 8.11 Soffit Detail – with Soffit Trim

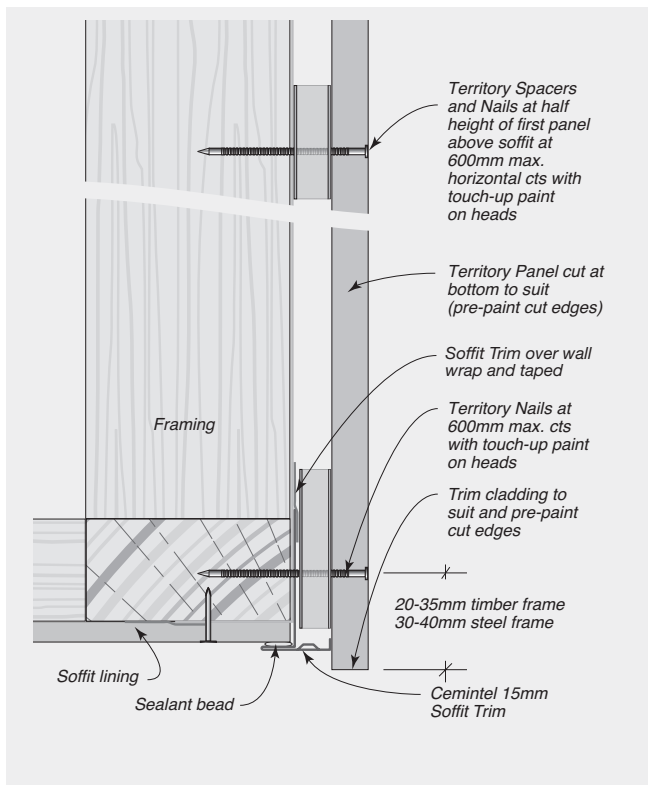
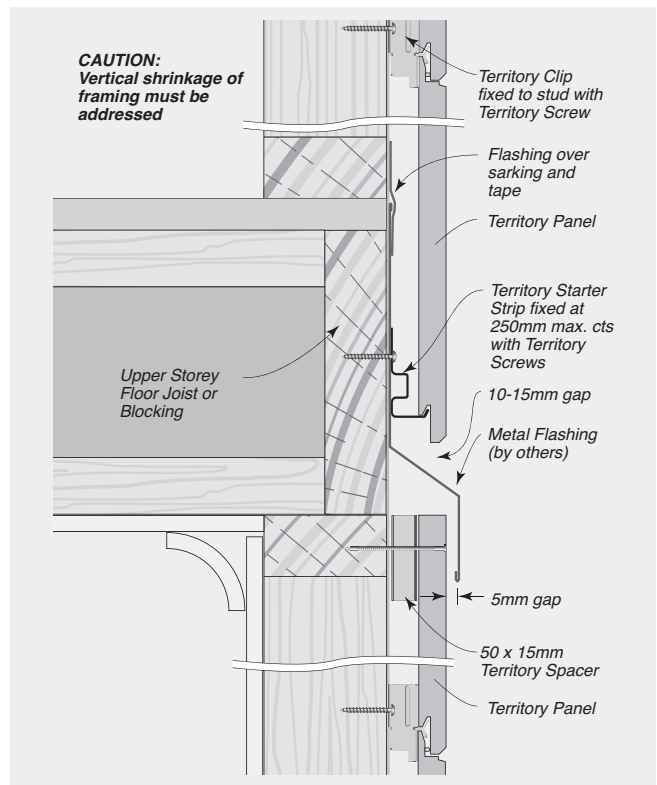

FIGURE 8.12 Horizontal Control Joint



CONSTRUCTION DRAWINGS AND DETAILS



Note: Drawings are interchangeable for timber or steel substrates with the exception of the fasteners.

GENERAL – Junction Details

FIGURE 8.13 Junction with External pitched Roofing

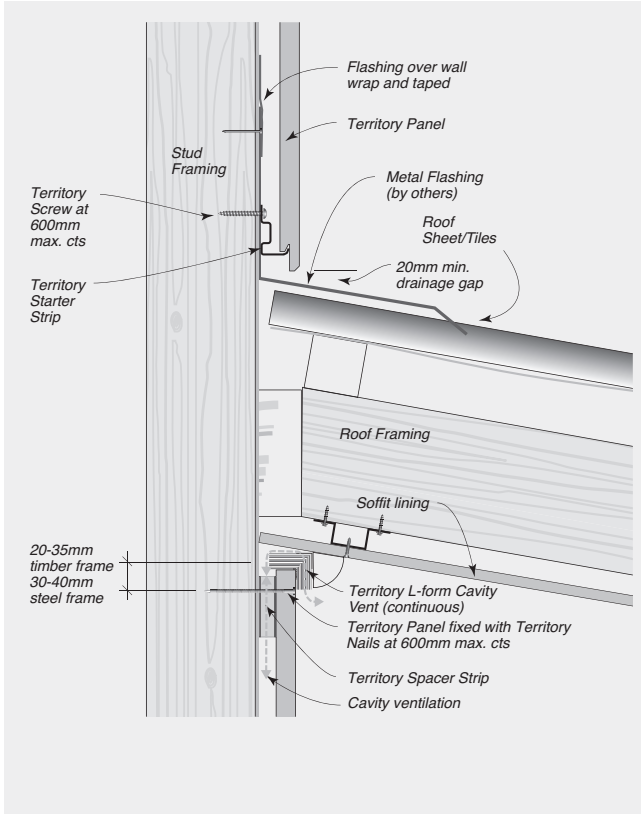

FIGURE 8.14 Junction with External flat Roofing

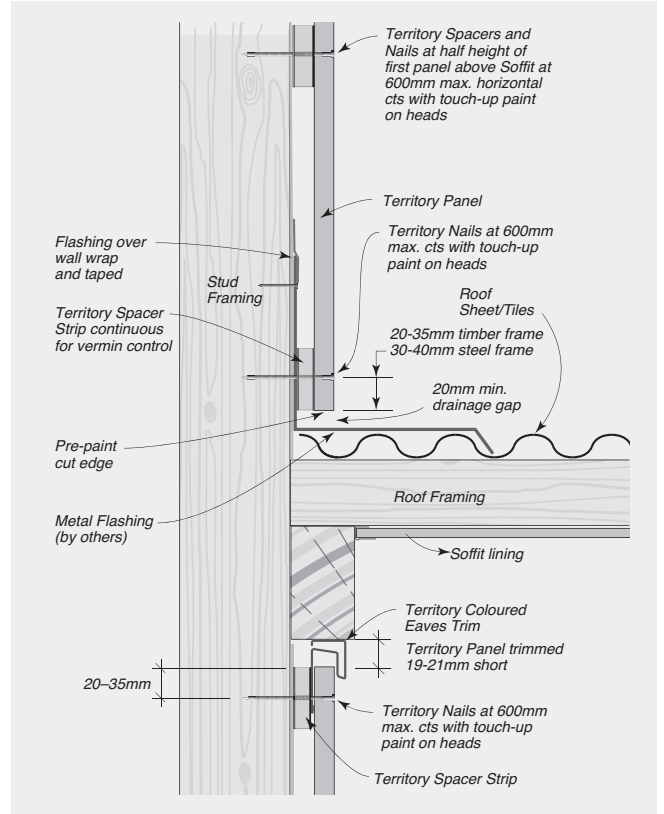

FIGURE 8.15 Junction with In-line Masonry Wall

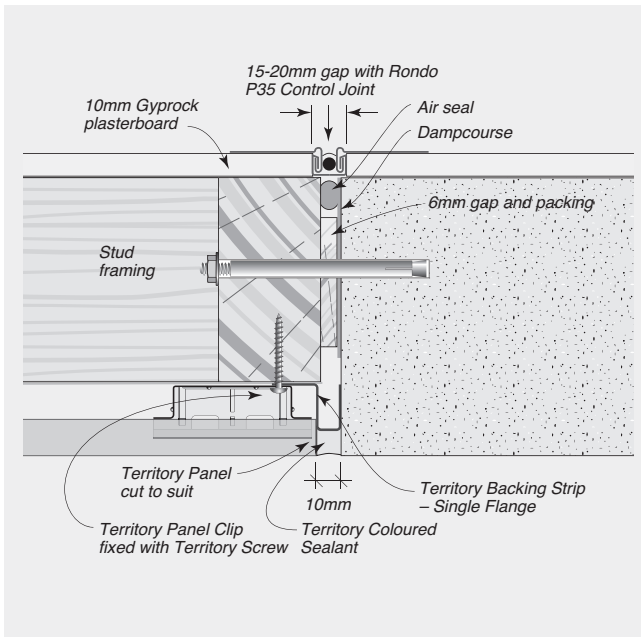
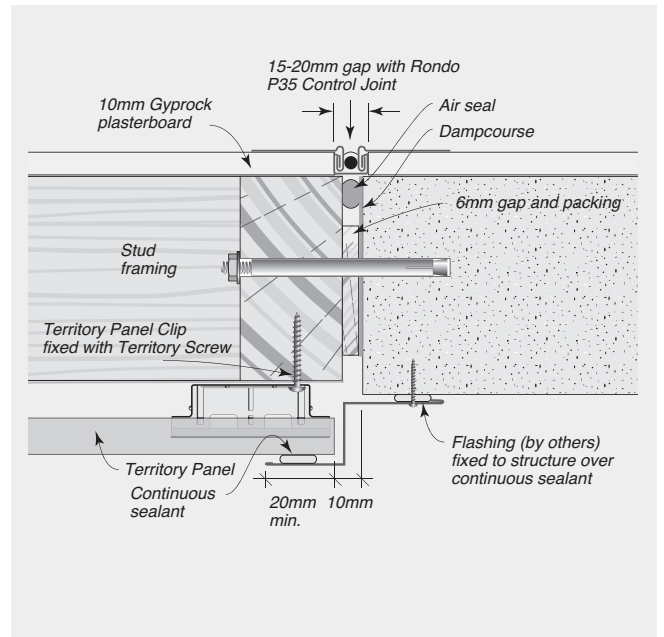

FIGURE 8.16 Junction with Offset Masonry Wall





CONSTRUCTION DRAWINGS AND DETAILS

Note: Drawings are interchangeable for timber or steel substrates with the exception of the fasteners.

GENERAL – Junction Details

FIGURE 8.17 Junction – Flushed with Brick Veneer

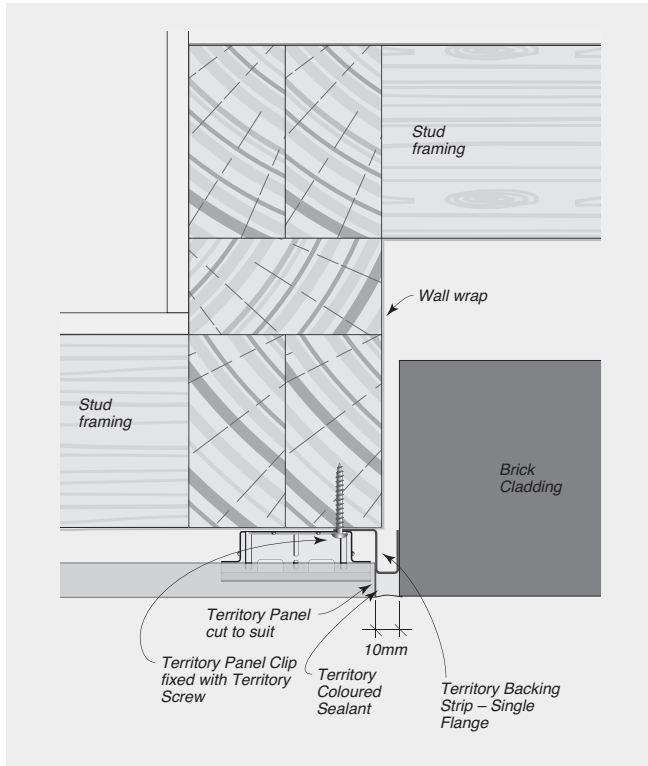

FIGURE 8.18 Junction – Recessed with Brick Veneer

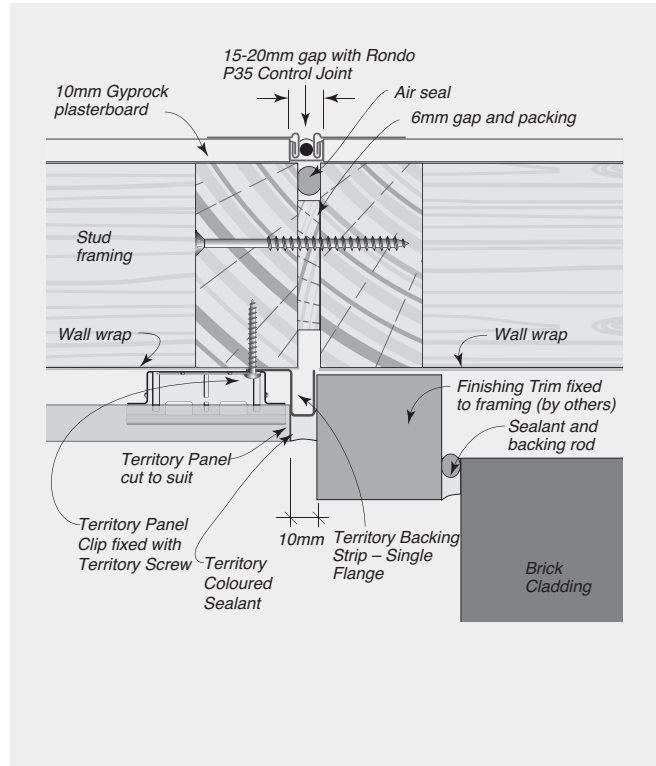
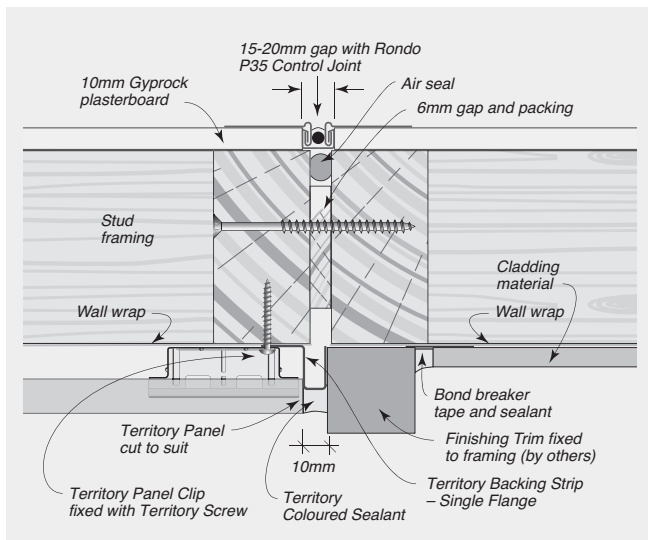

FIGURE 8.19 Typical Junction Detail with Fibre Cement Cladding System



CONSTRUCTION DRAWINGS AND DETAILS



Note: Drawings are interchangeable for timber or steel substrates with the exception of the fasteners.

GENERAL - Junction Details

FIGURE 8.20 Framing and Control Joint Detail at Edge Beam – Edge Beam height less than 450mm (Continuous Wall Wrap/Sarking Method)

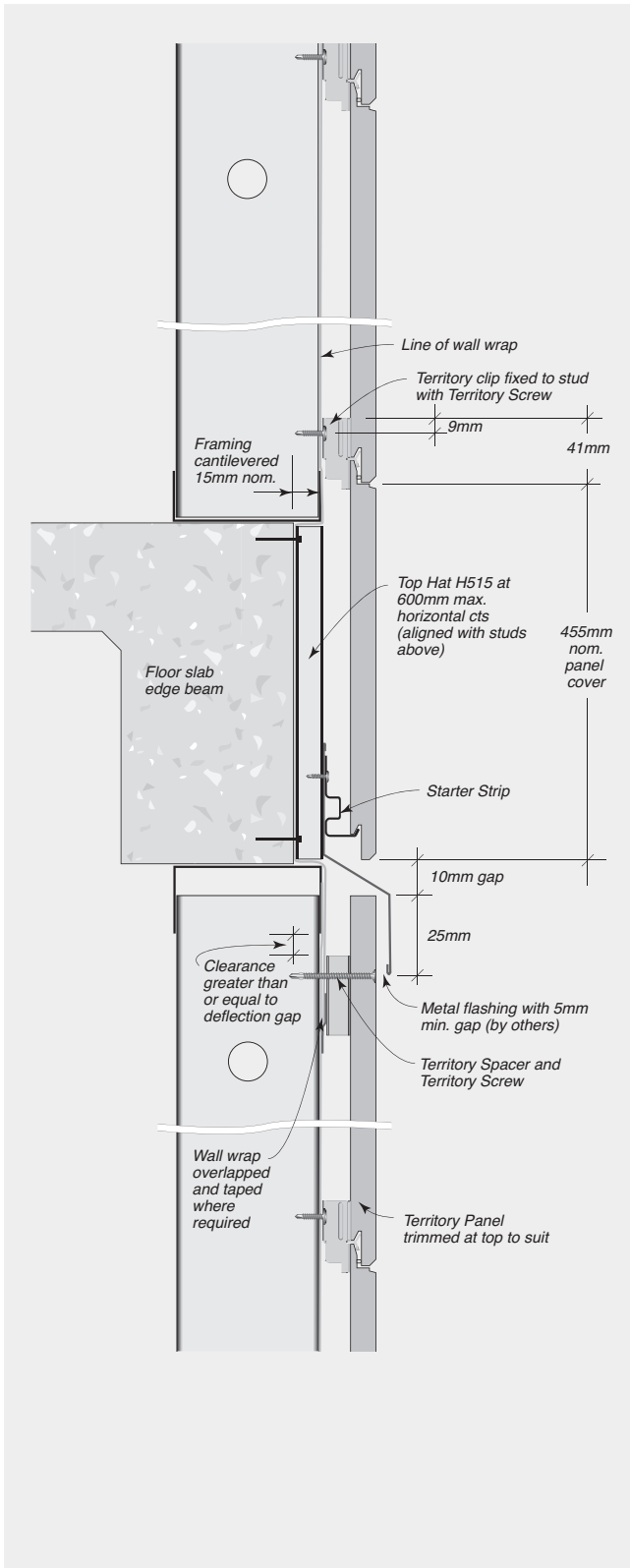
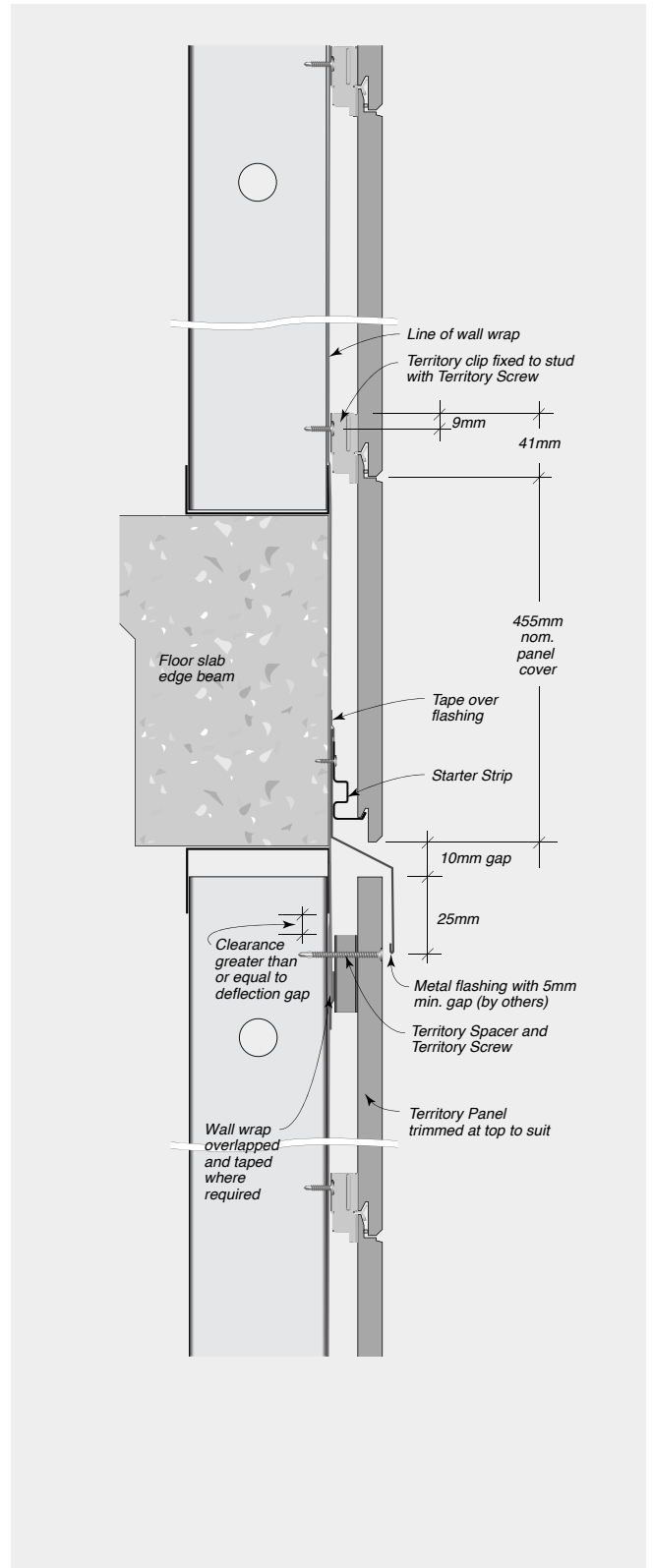

FIGURE 8.21 Edge Beam Detail – Horizontal Top Hat





CONSTRUCTION DRAWINGS AND DETAILS

Note: Drawings are interchangeable for timber or steel substrates with the exception of the fasteners.

GENERAL – Window Details

FIGURE 8.22 A&L Aluminium Awning Window with Weatherboard Trim

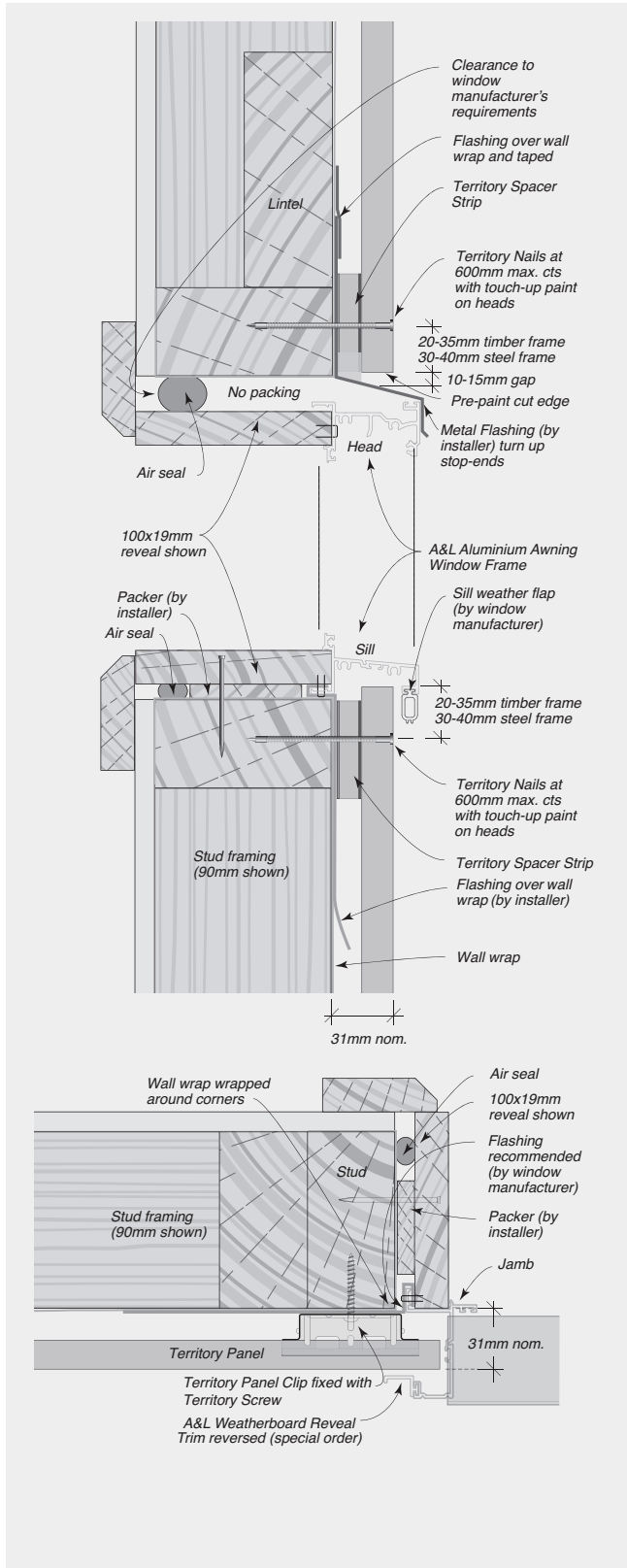
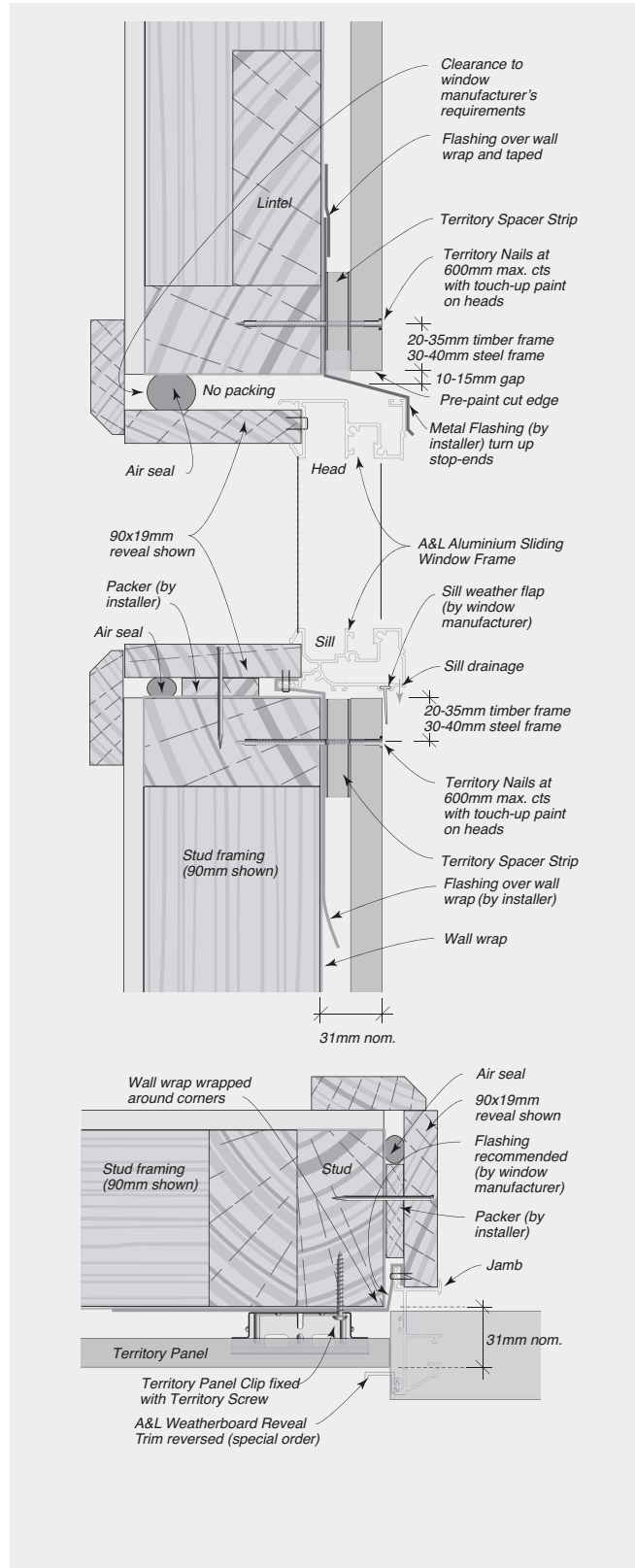

FIGURE 8.23 A&L Aluminium Sliding Window with Weatherboard Trim



CONSTRUCTION DRAWINGS AND DETAILS



Note: Drawings are interchangeable for timber or steel substrates with the exception of the fasteners.

GENERAL - Window Details

FIGURE 8.24 Trend 48mm Aluminium Awning Window

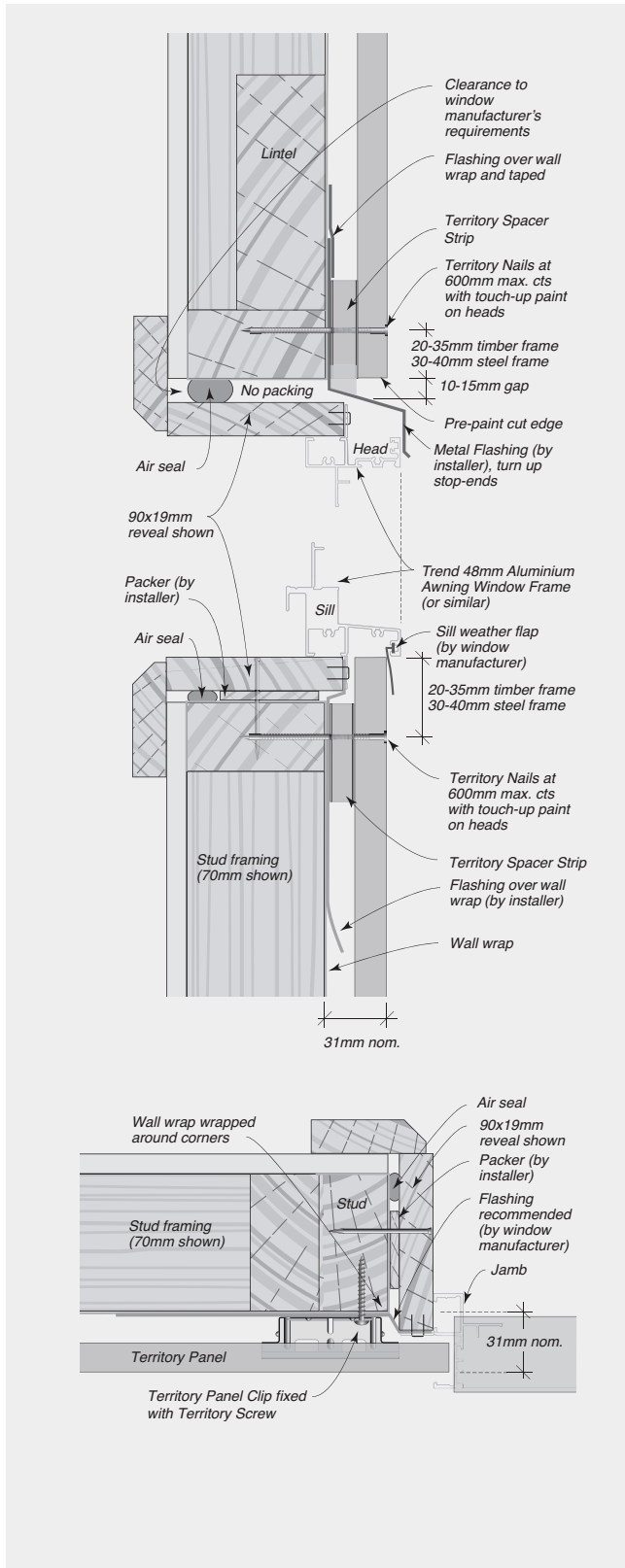
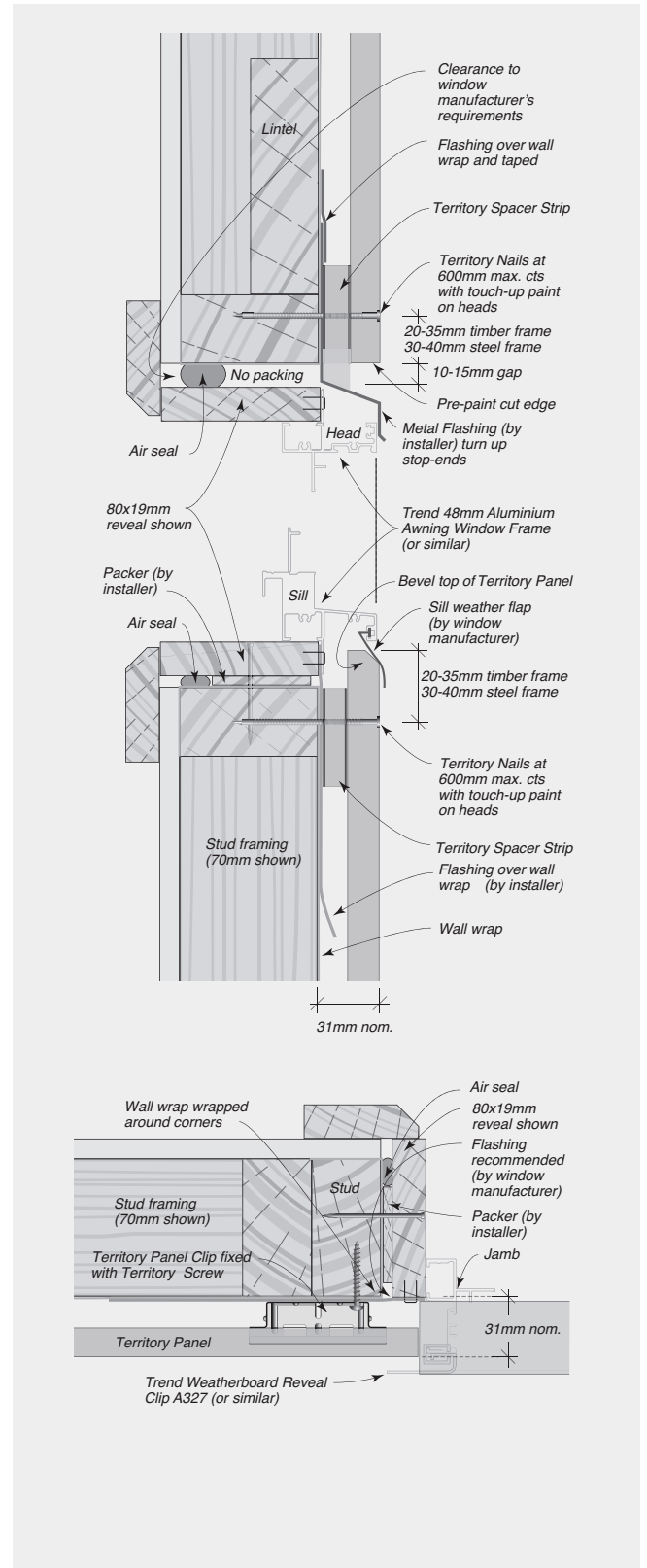

FIGURE 8.25 Trend 48mm Aluminium Awning Window with Weatherboard Reveal Clip A327





CONSTRUCTION DRAWINGS AND DETAILS

Note: Drawings are interchangeable for timber or steel substrates with the exception of the fasteners.

GENERAL – Window Details

FIGURE 8.26 Trend Quantum XP Aluminium Sliding Window with Weatherboard Reveal Clip E482

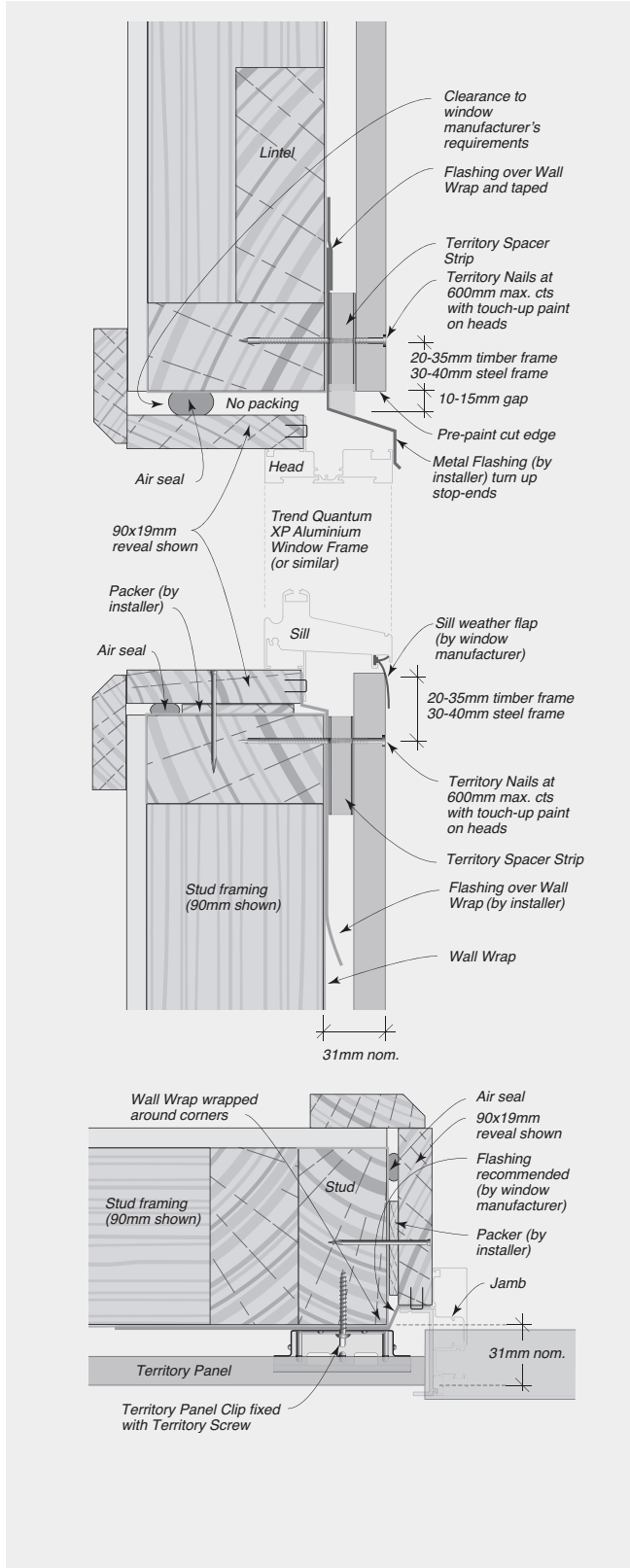
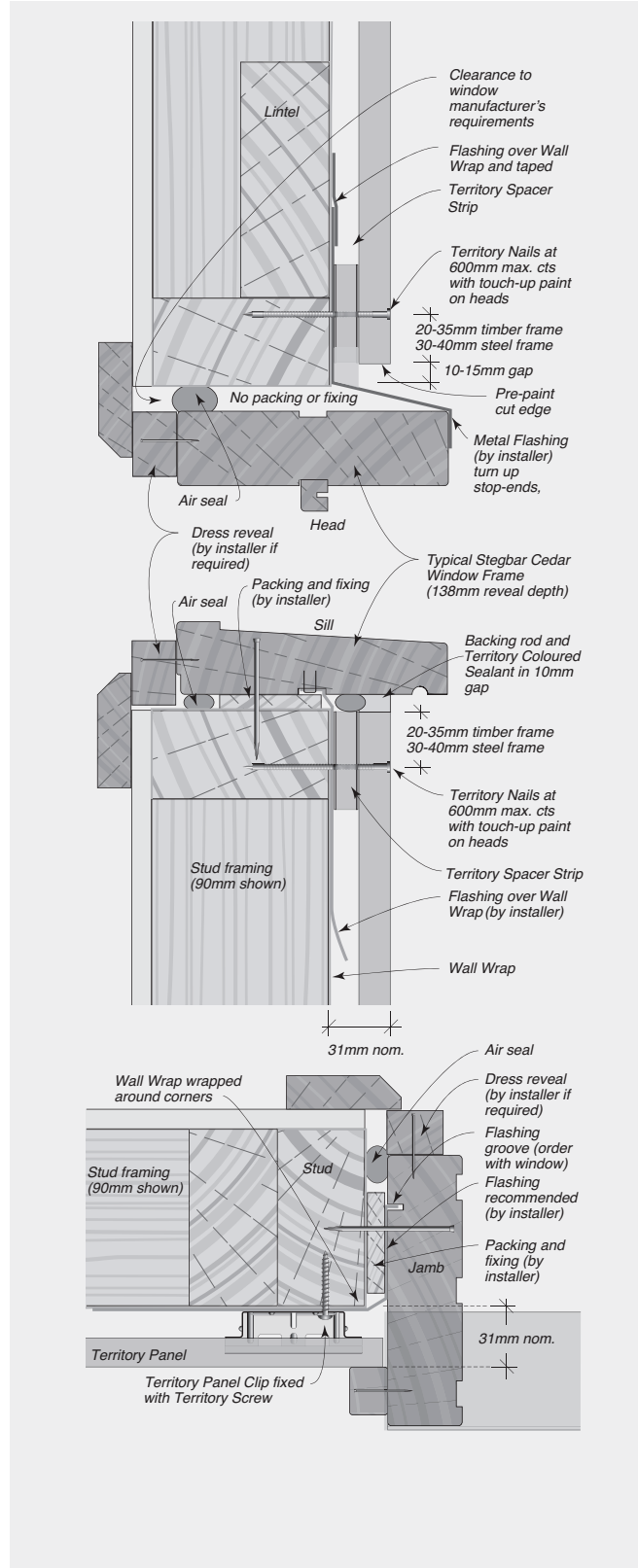

FIGURE 8.27 Typical Stegbar Window



CONSTRUCTION DRAWINGS AND DETAILS



Note: Drawings are interchangeable for timber or steel substrates with the exception of the fasteners.

GENERAL - Window Details

FIGURE 8.28 Window with Mitre Corners

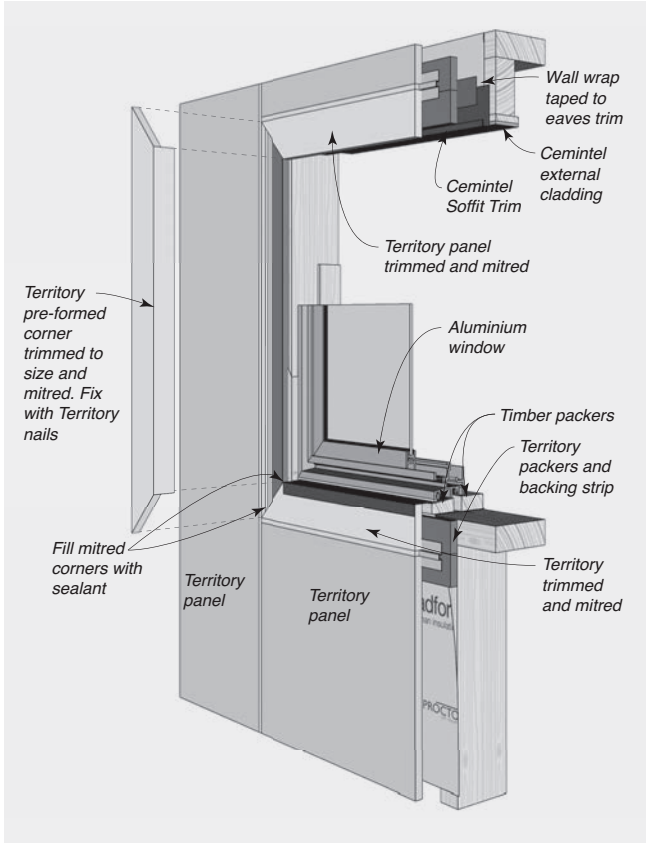
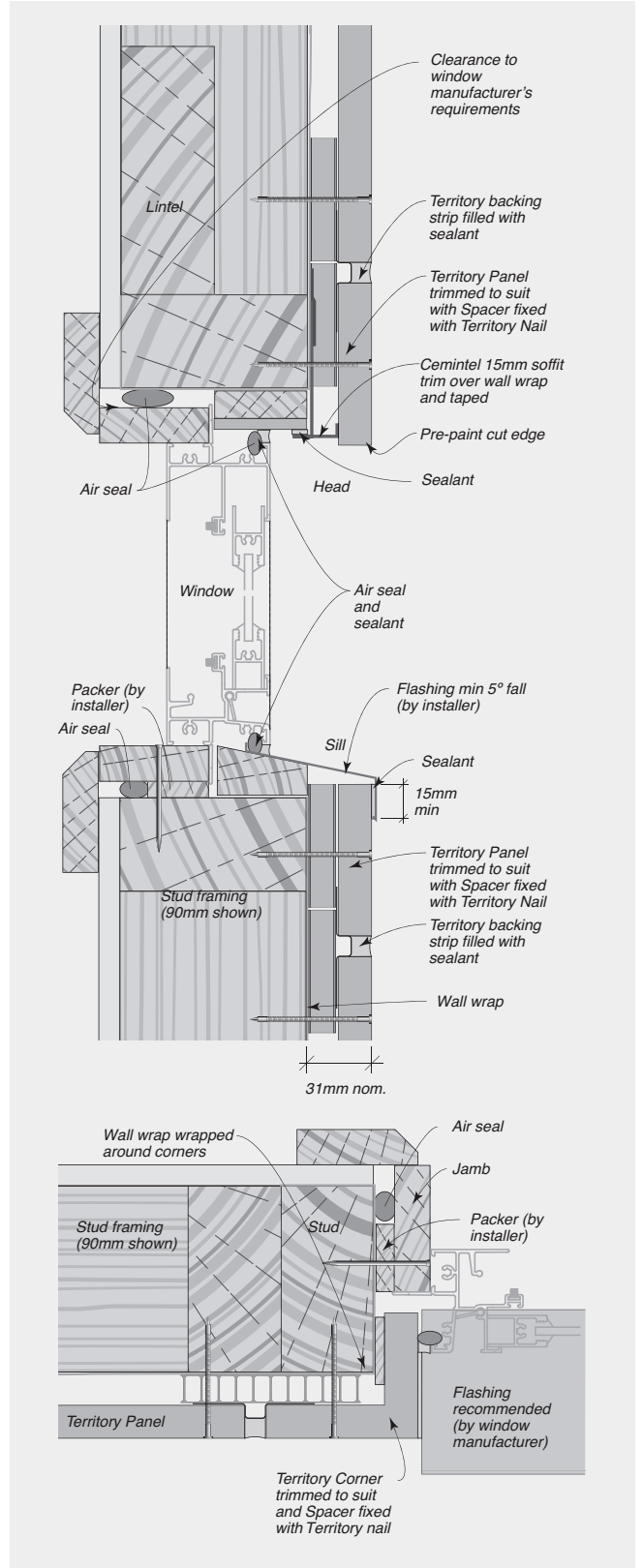

FIGURE 8.29 Window Reveal





CONSTRUCTION DRAWINGS AND DETAILS

Note: Drawings are interchangeable for timber or steel substrates with the exception of the fasteners.

GENERAL – Window Details

FIGURE 8.30 Generic Commercial Window

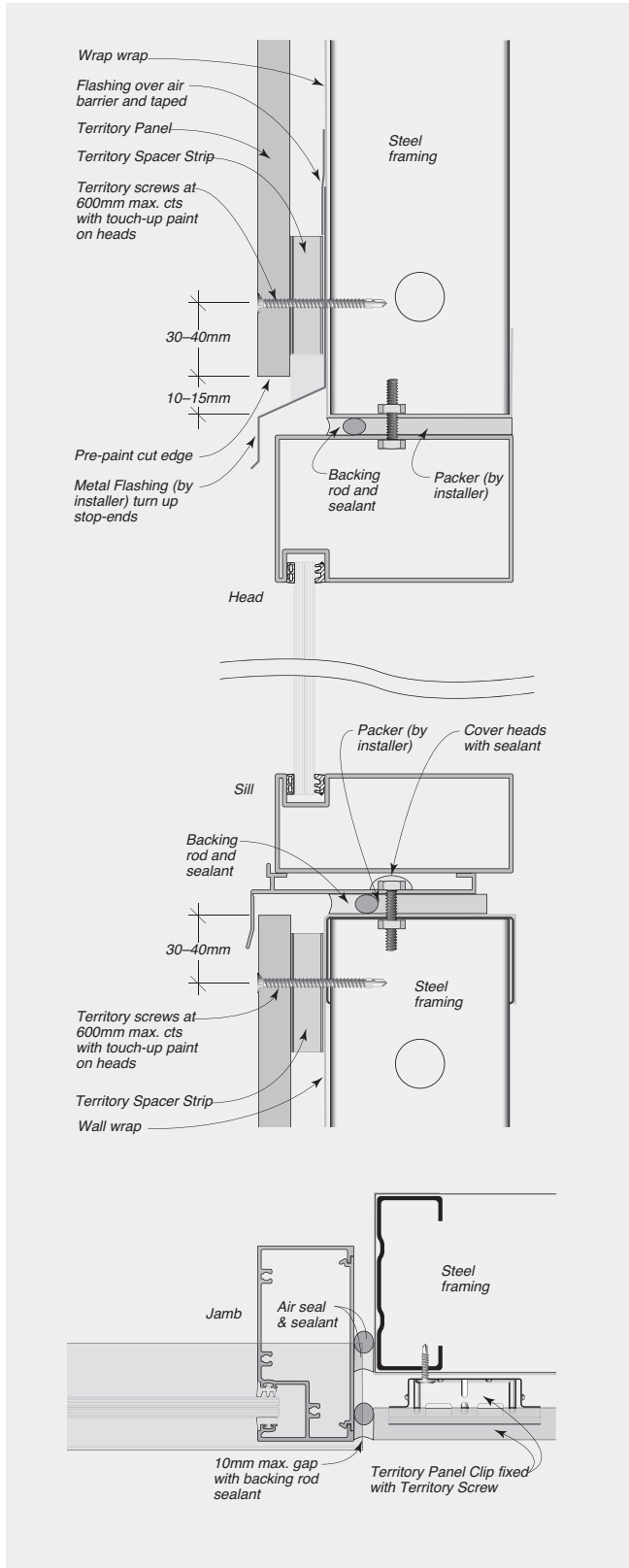
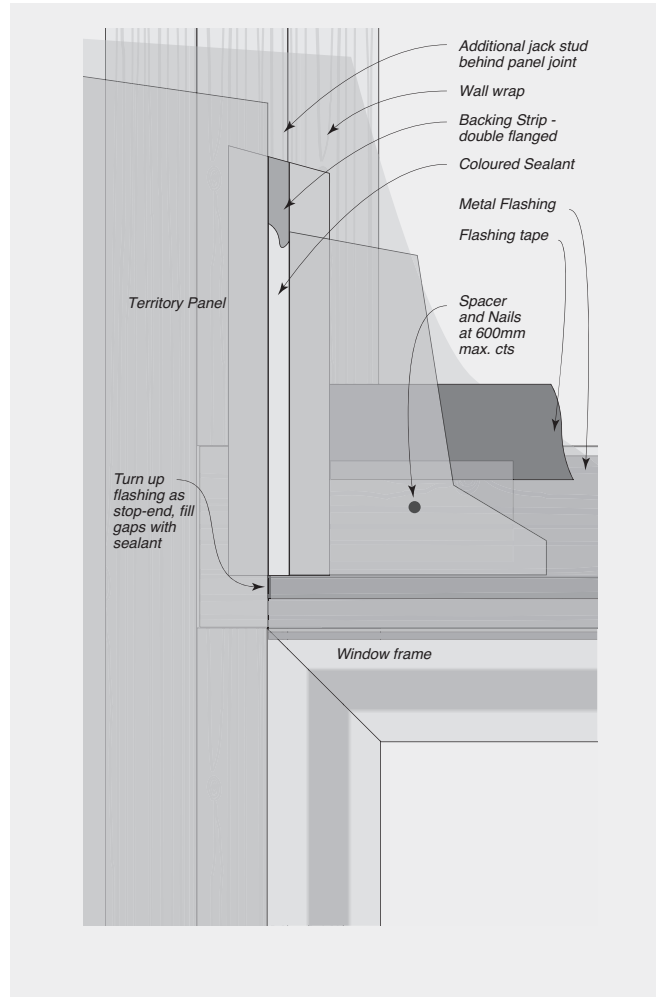

FIGURE 8.31 Typical Window



CONSTRUCTION DRAWINGS AND DETAILS



Note: Drawings are interchangeable for timber or steel substrates with the exception of the fasteners.

GENERAL - Door Details

FIGURE 8.32 Dowell Sliding Door Installation
- 70mm Framing and 85mm Reveal

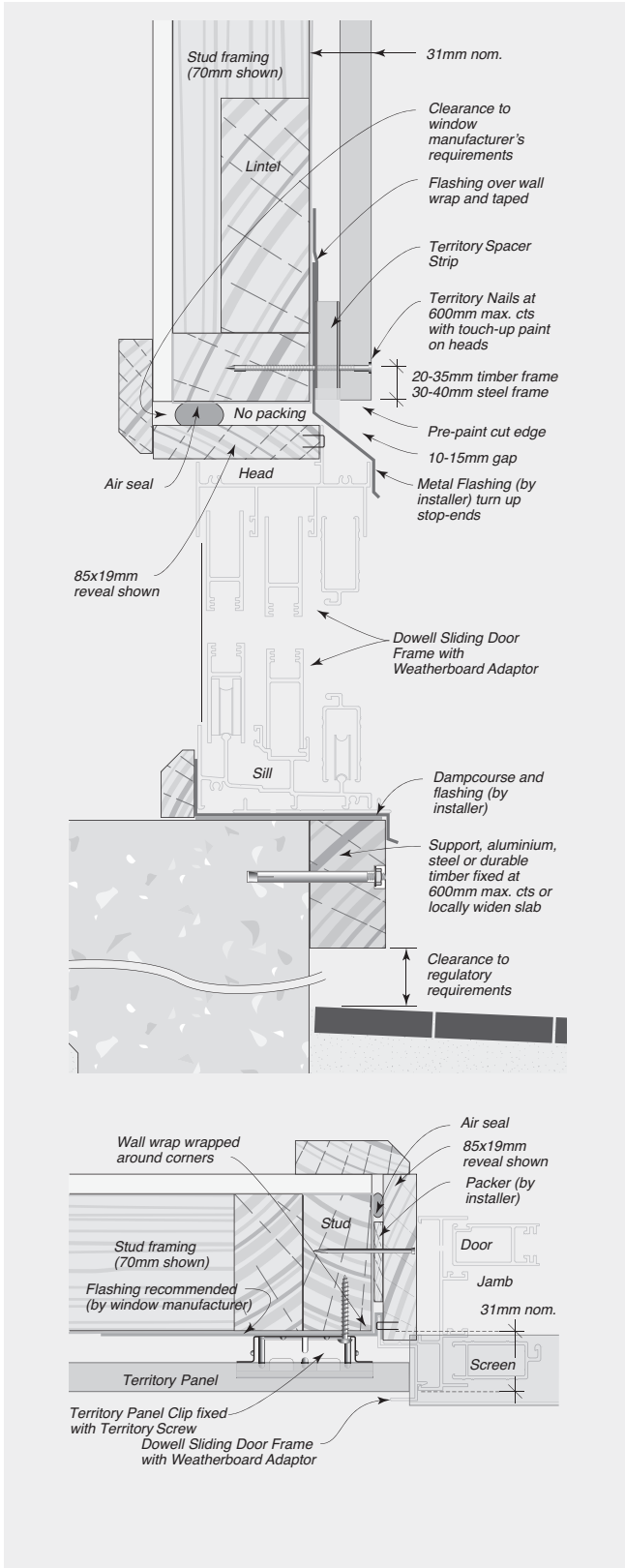
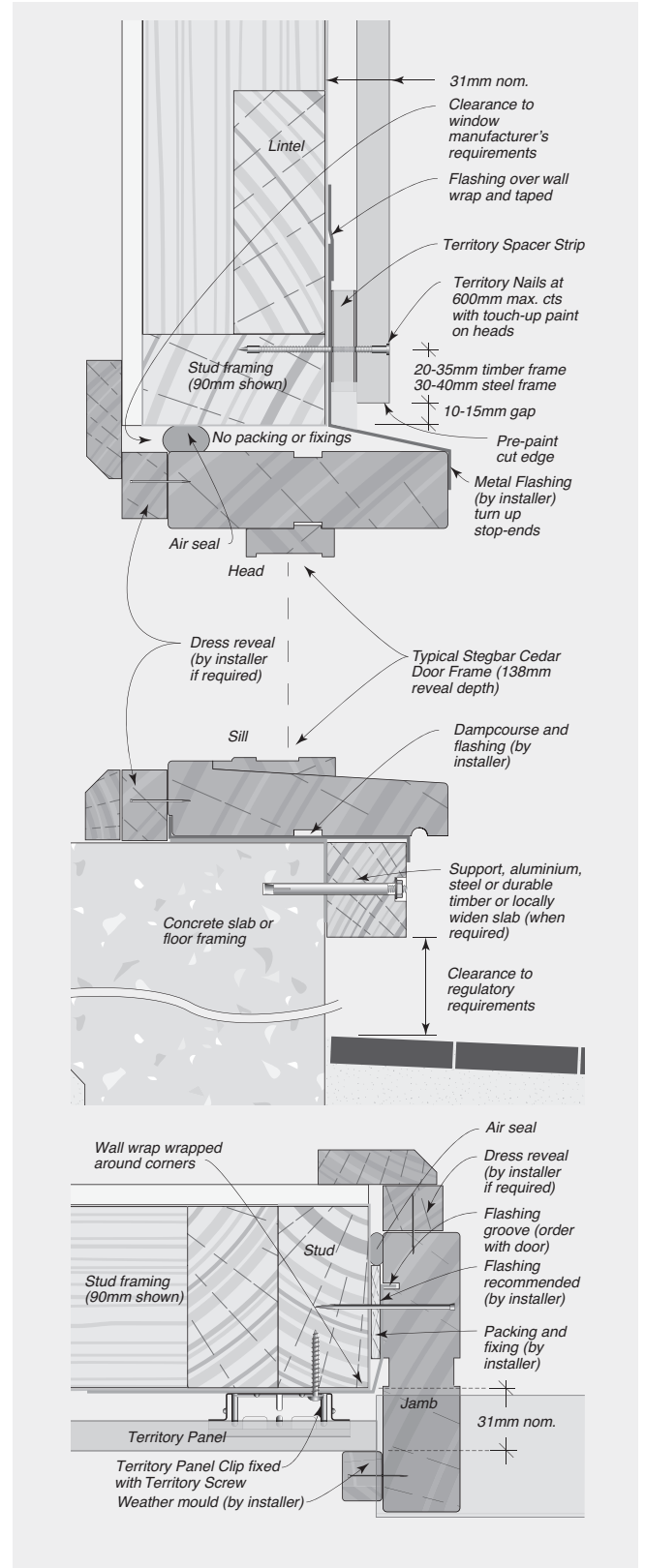

FIGURE 8.33 Typical Stegbar Sliding or Entry Door





CONSTRUCTION DRAWINGS AND DETAILS

Note: Drawings are interchangeable for timber or steel substrates with the exception of the fasteners.

GENERAL – Parapet Details

FIGURE 8.34 Typical Parapet/Roof Junction

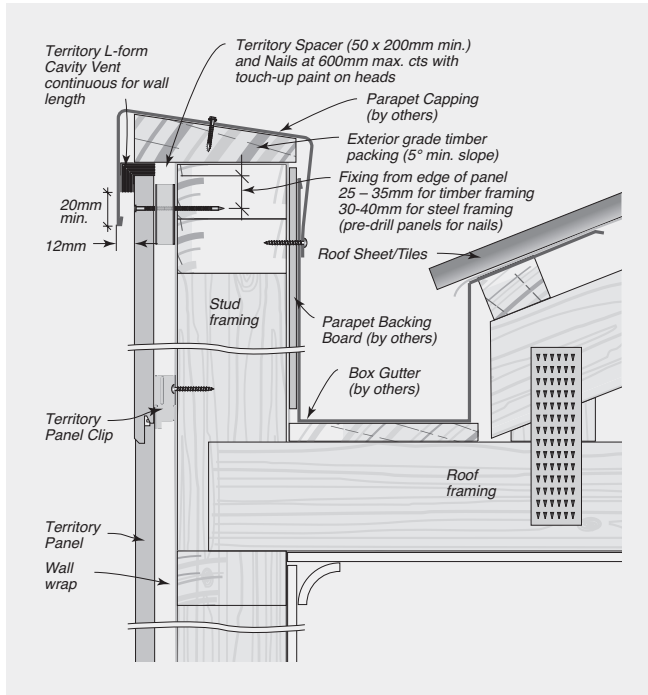
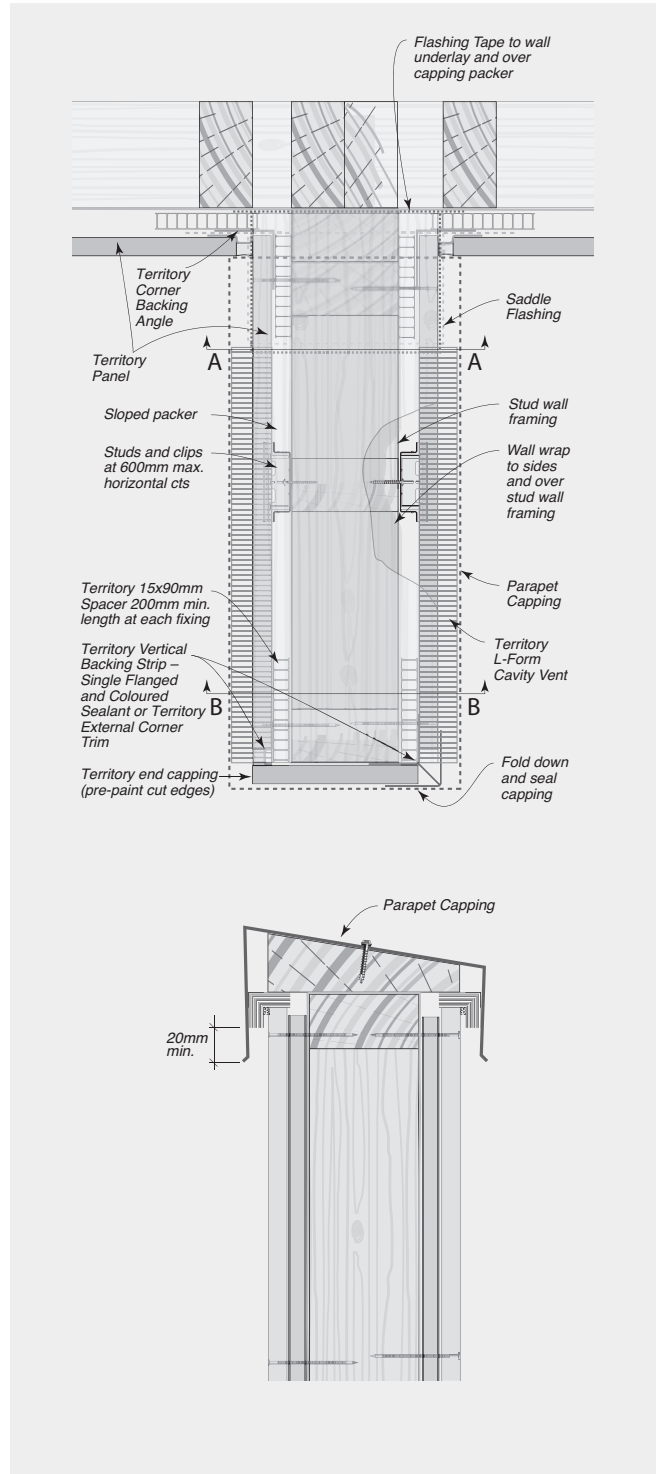

FIGURE 8.35 Parapet Wall



CONSTRUCTION DRAWINGS AND DETAILS



Note: Drawings are interchangeable for timber or steel substrates with the exception of the fasteners.

GENERAL – Parapet Details

FIGURE 8.36 Parapet Wall Junction – Stage 1

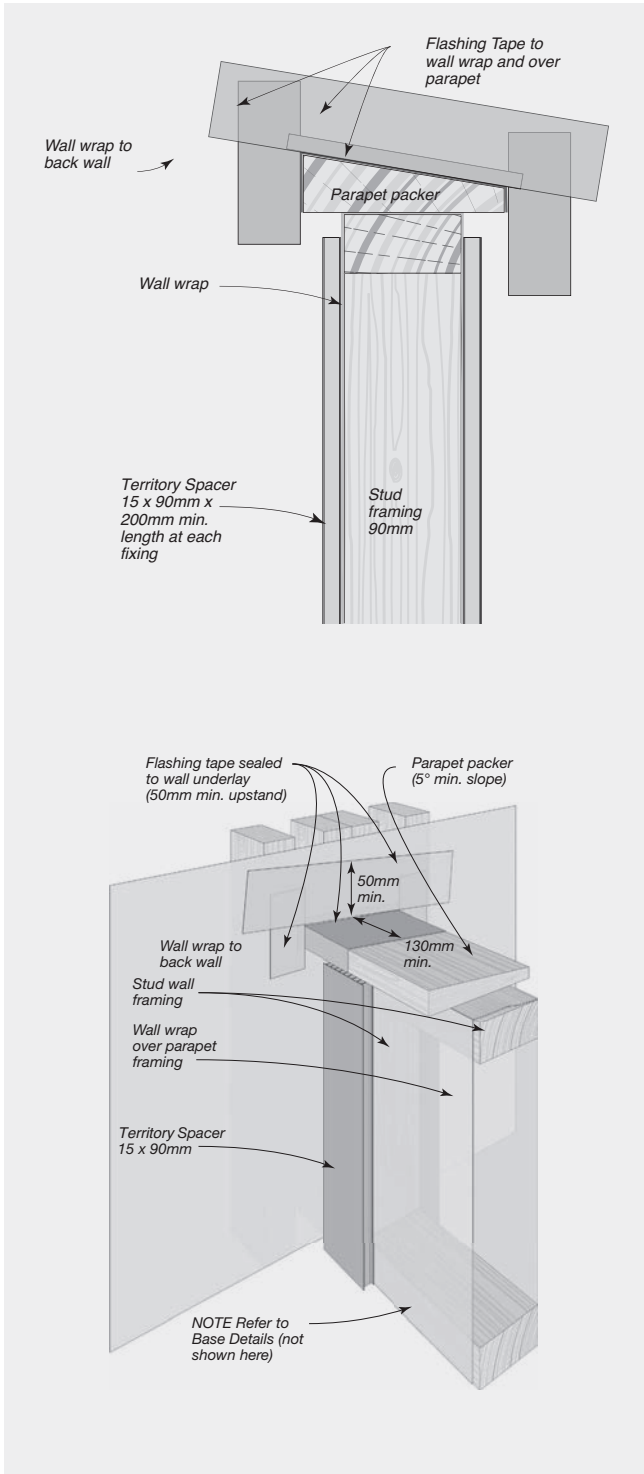
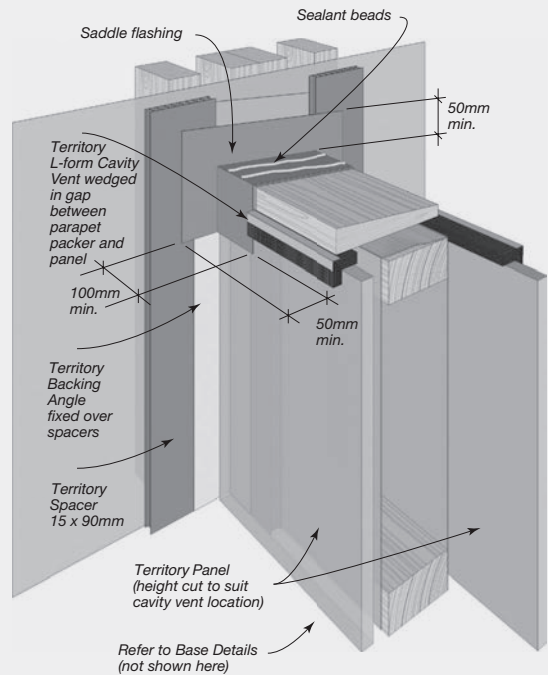
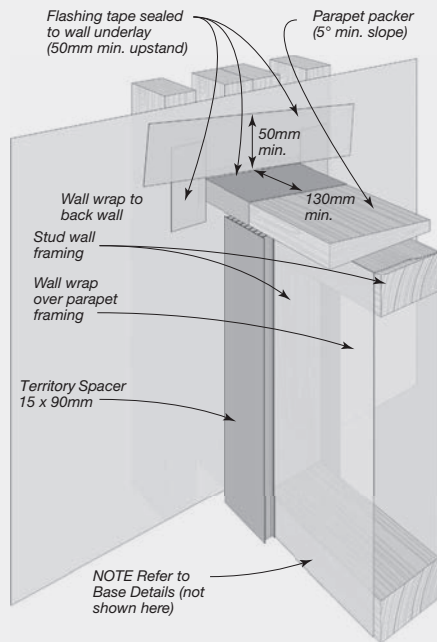
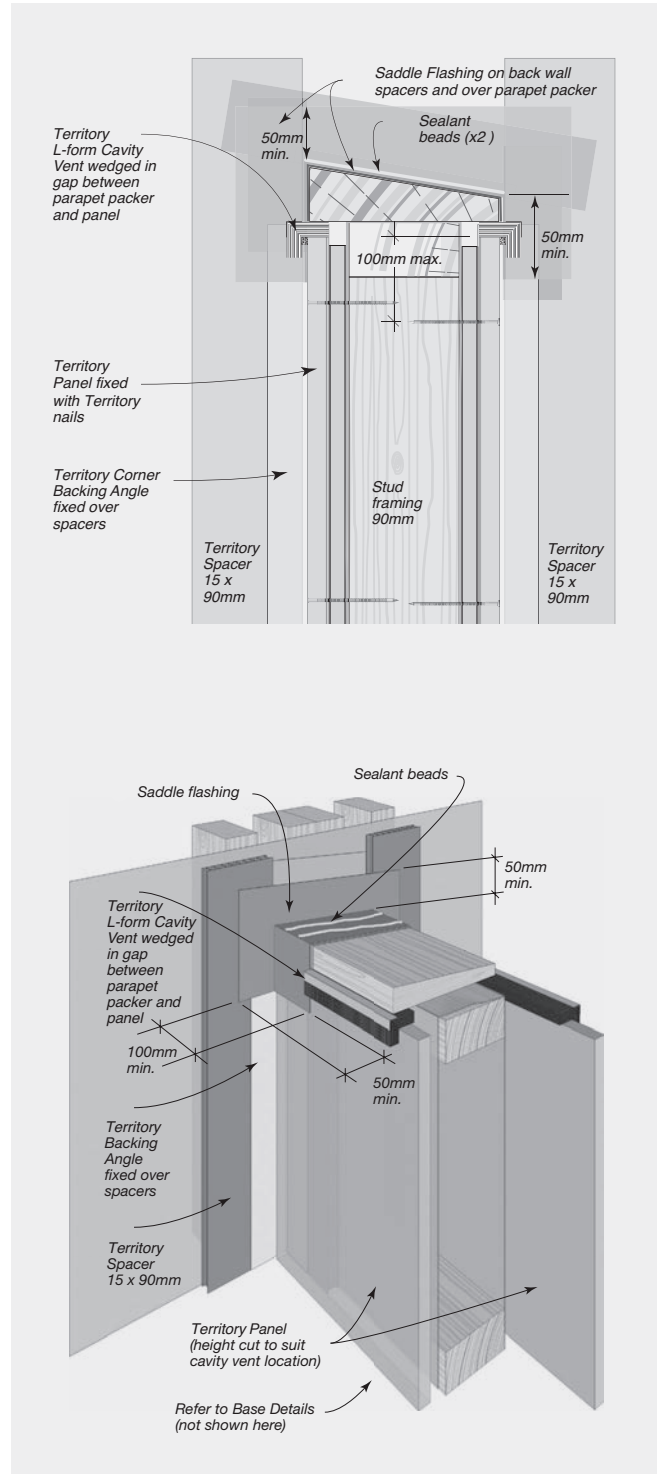

FIGURE 8.37 Parapet Wall Junction – Stage 2





CONSTRUCTION DRAWINGS AND DETAILS

Note: Drawings are interchangeable for timber or steel substrates with the exception of the fasteners.

GENERAL – Parapet Details

FIGURE 8.38 Parapet Wall Junction – Stage 3

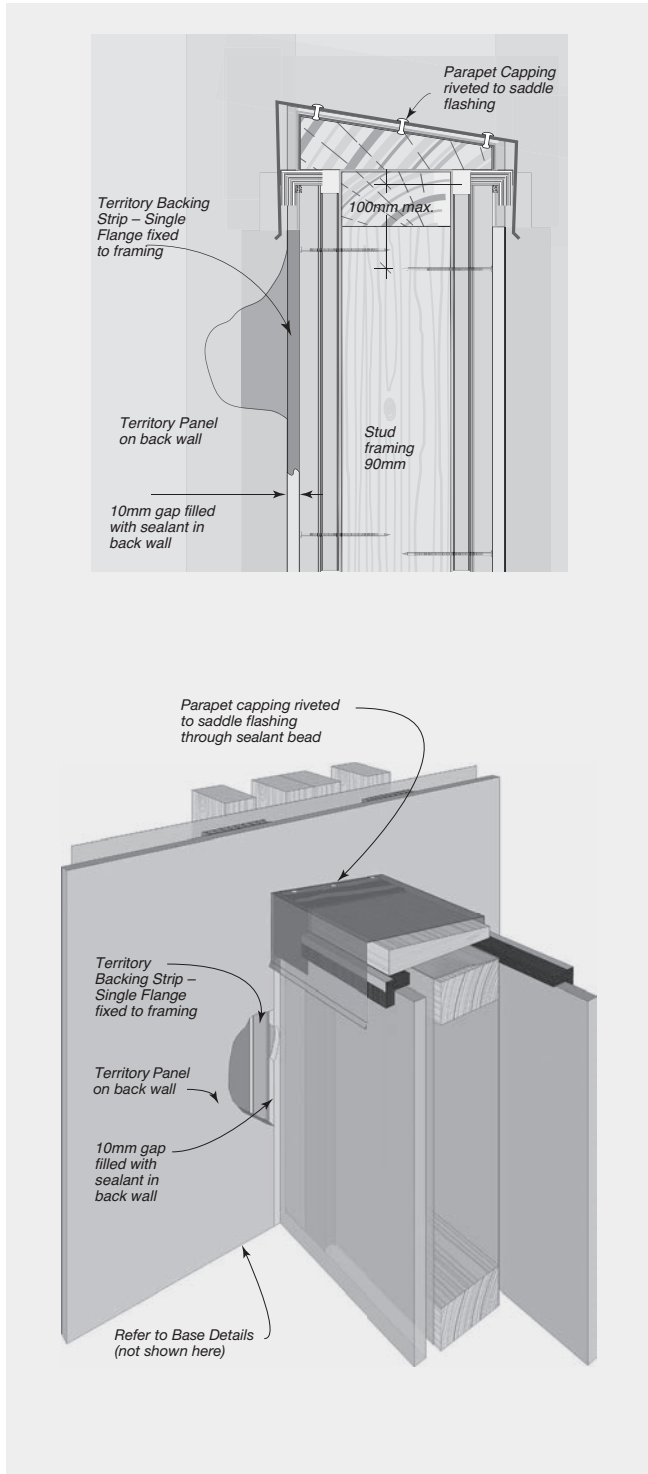

GENERAL – Balcony Details

FIGURE 8.39 Typical Balcony Detail

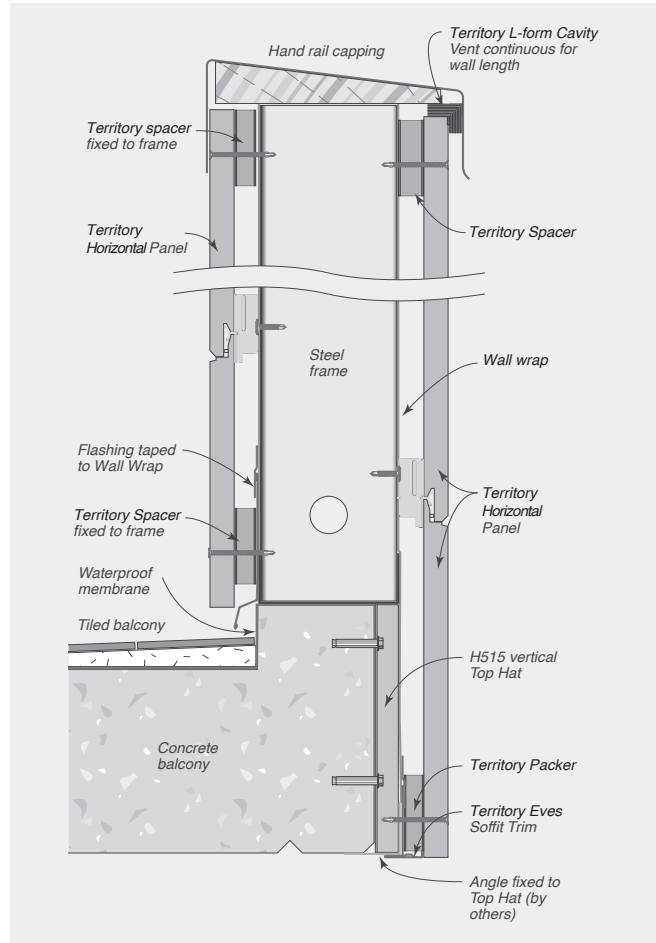

CONSTRUCTION DRAWINGS AND DETAILS



Note: Drawings are interchangeable for timber or steel substrates with the exception of the fasteners.

GENERAL – Power/Meter Box Details

FIGURE 8.40 Typical Power/Meter Box – Mounted to Face of Framing

Note: Refer to local authority for specific meterbox installation requirements

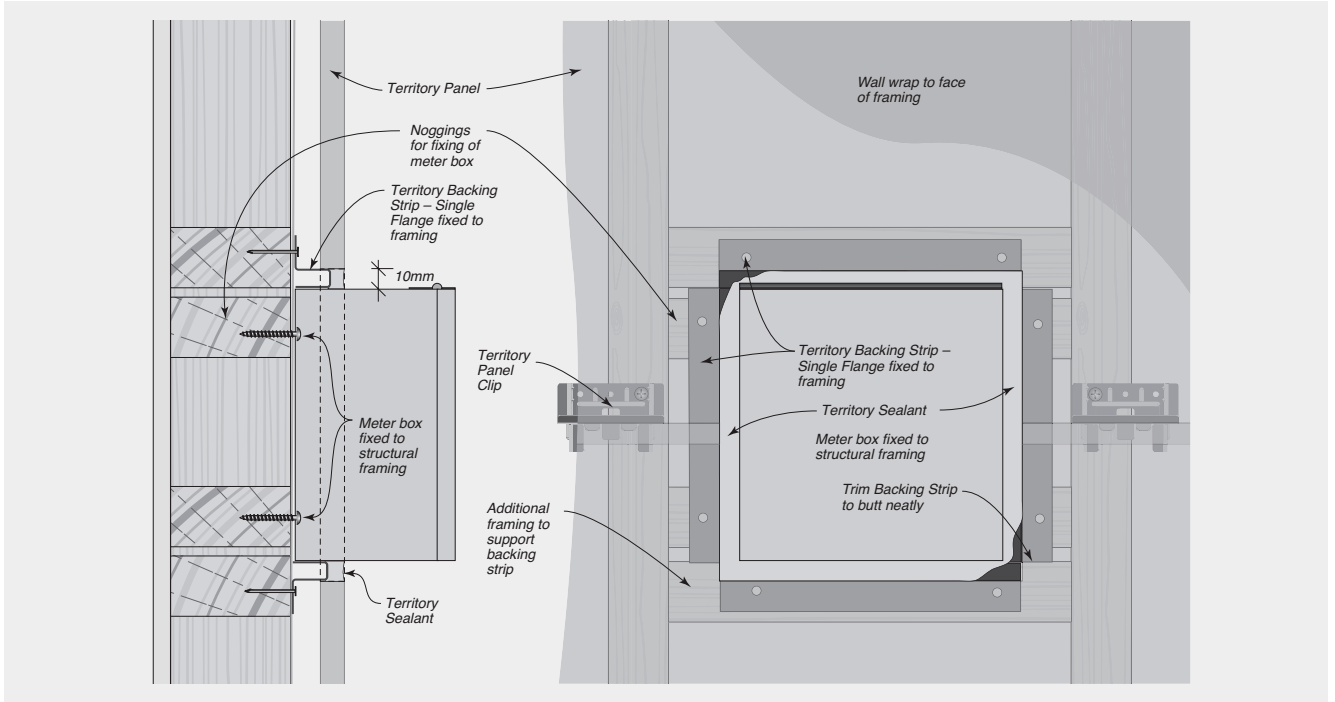
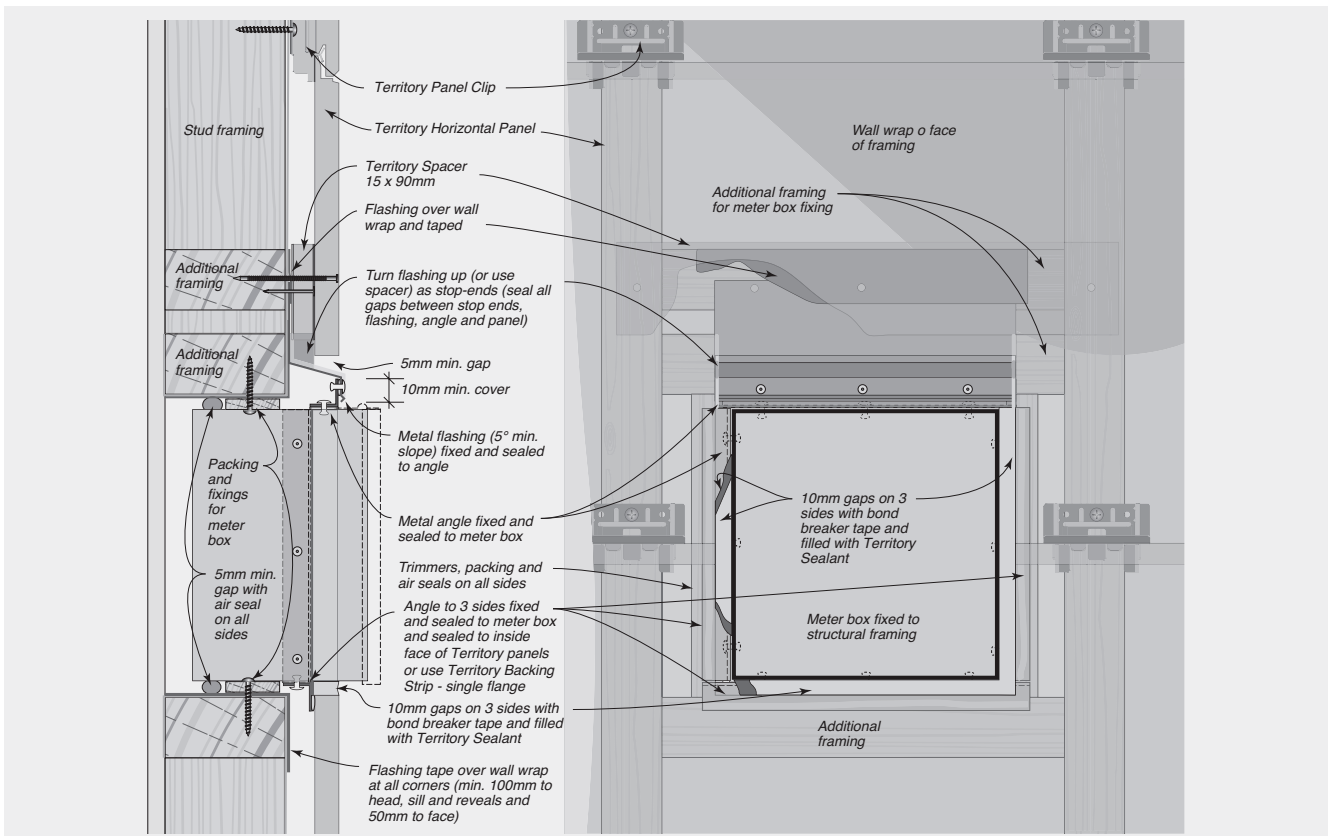

FIGURE 8.41 Typical Power/Meter Box – Recessed into Framing

Note: Refer to local authority for specific meterbox installation requirements





CONSTRUCTION DRAWINGS AND DETAILS

Note: Drawings are interchangeable for timber or steel substrates with the exception of the fasteners.

GENERAL – Masonry Details

FIGURE 8.42 Typical Base

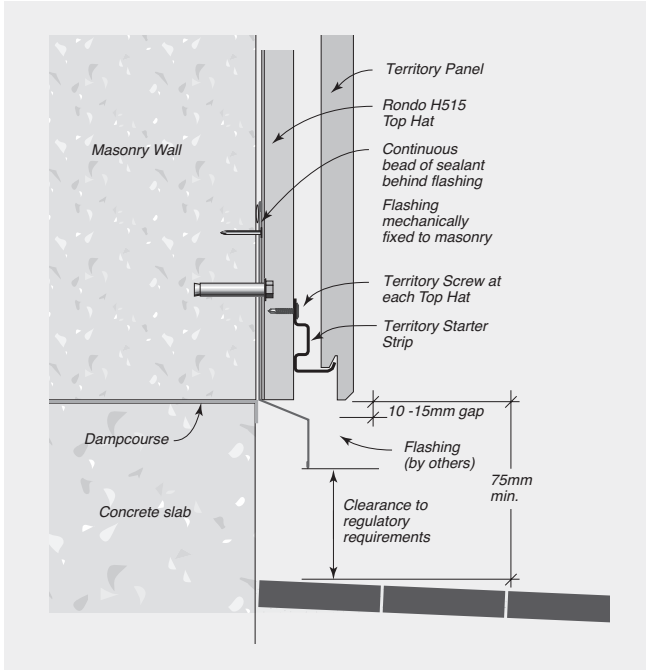

FIGURE 8.43 External Corner Detail – with Aluminium External Corner

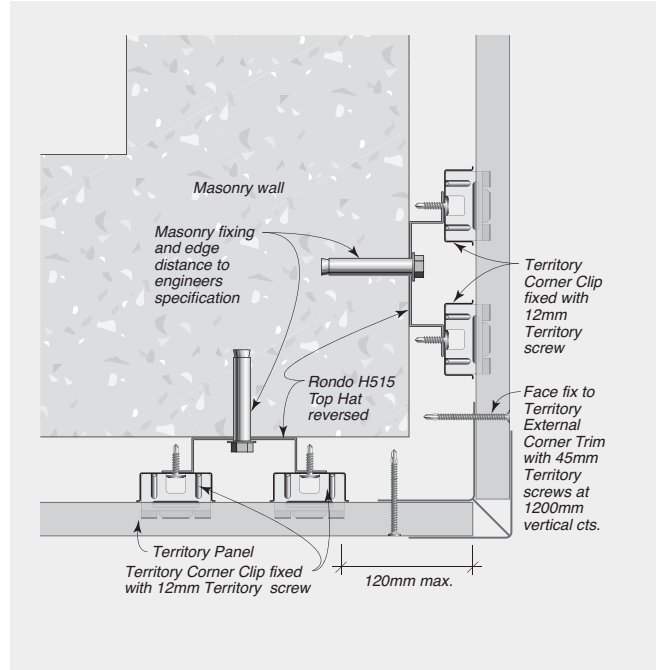

FIGURE 8.44 Internal Corner Detail – with Backing Strip and Coloured Sealant

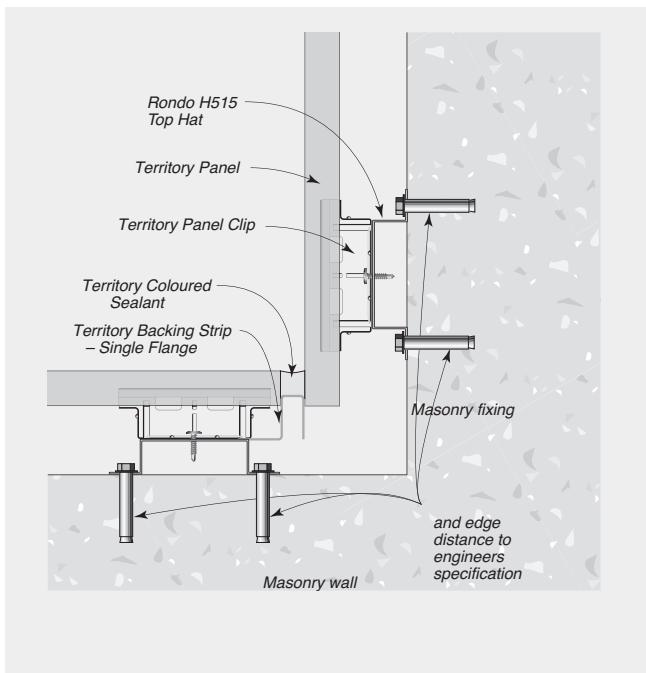
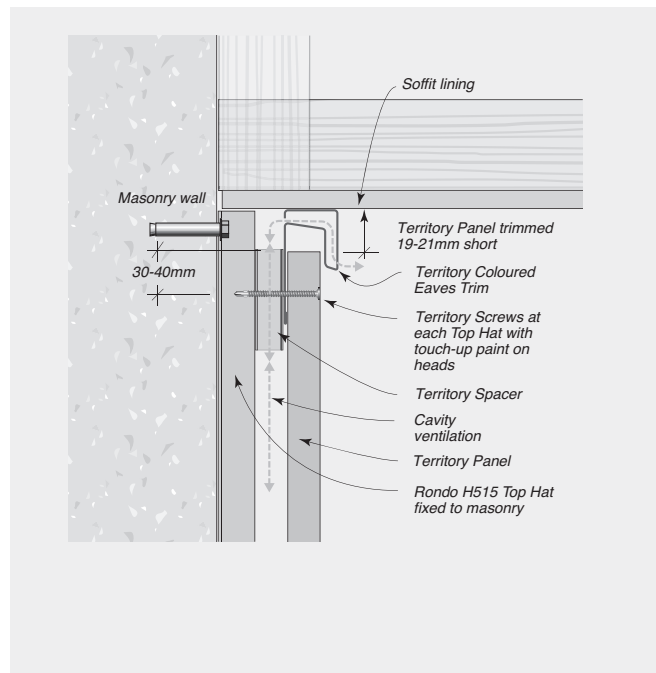

FIGURE 8.45 Soffit Detail – with Coloured Eaves Trim



CONSTRUCTION DRAWINGS AND DETAILS



Note: Drawings are interchangeable for timber or steel substrates with the exception of the fasteners.

GENERAL – Masonry Details

FIGURE 8.46 Masonry Junction Detail

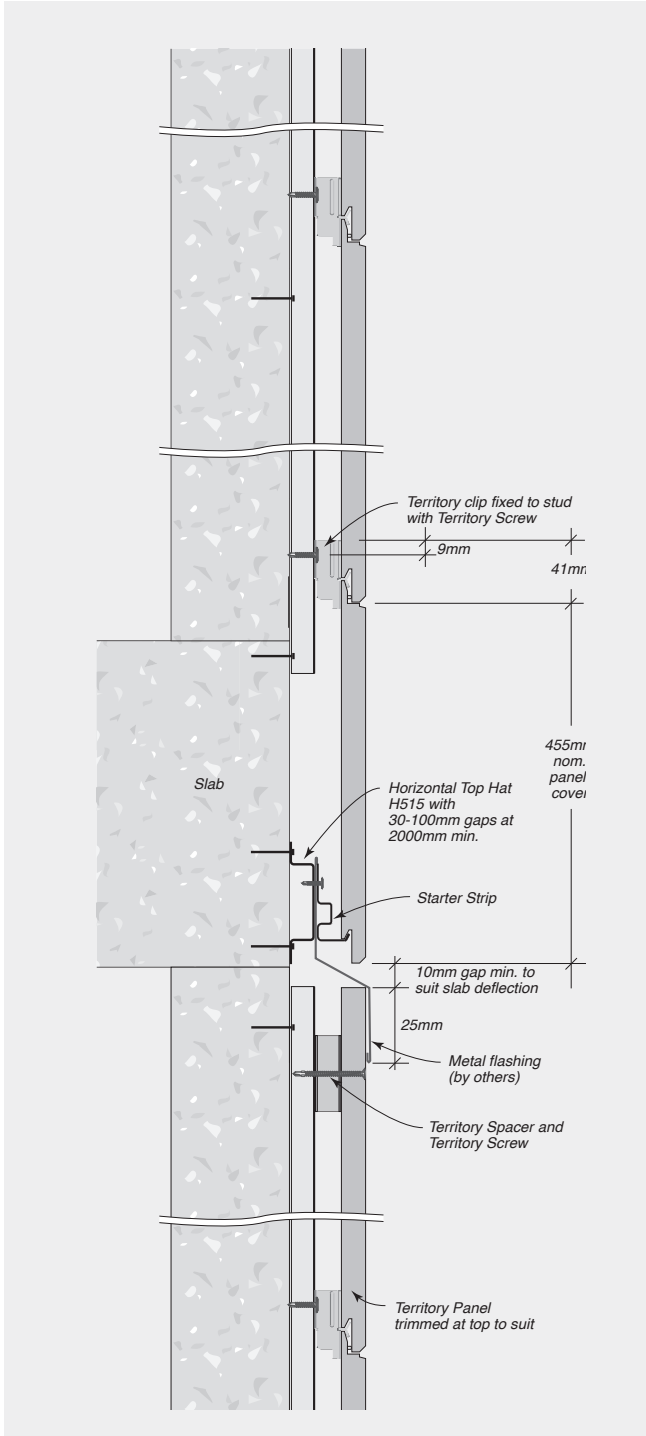

FIGURE 8.47 Vertical Panel Joint (Option 1)

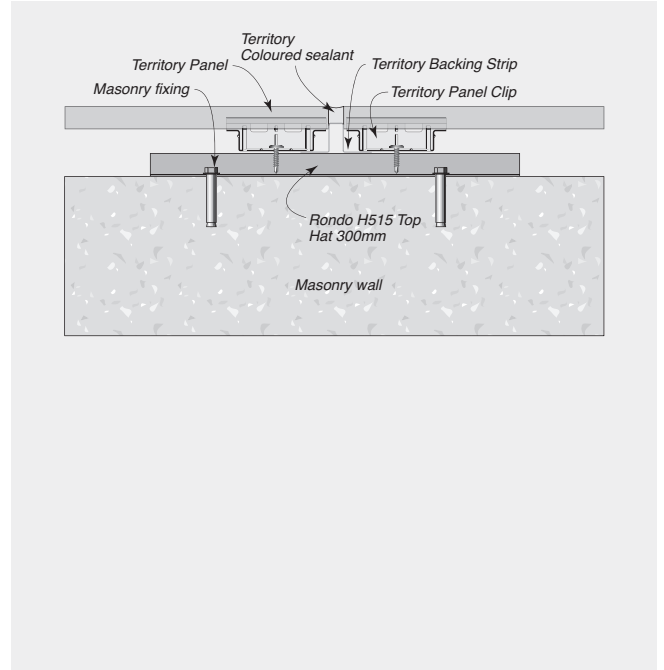
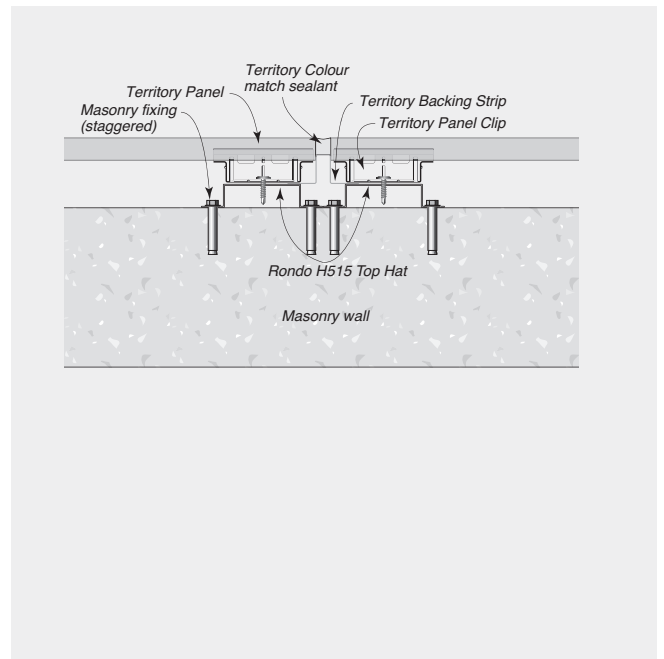

FIGURE 8.48 Vertical Panel Joint (Option 2)





CONSTRUCTION DRAWINGS AND DETAILS

Note: Drawings are interchangeable for timber or steel substrates with the exception of the fasteners.

GENERAL – Masonry Details

FIGURE 8.49 Window Detail – A&L Aluminium Awning Window with Weatherboard Trim

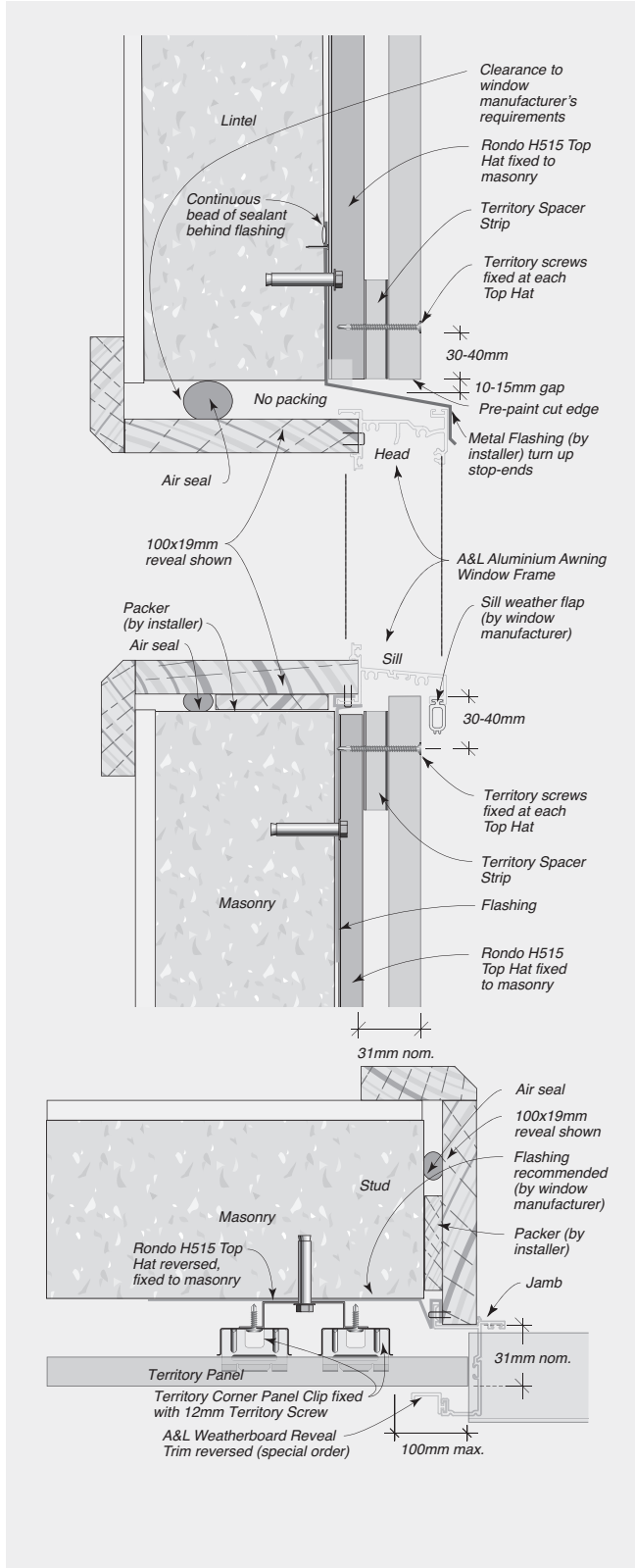
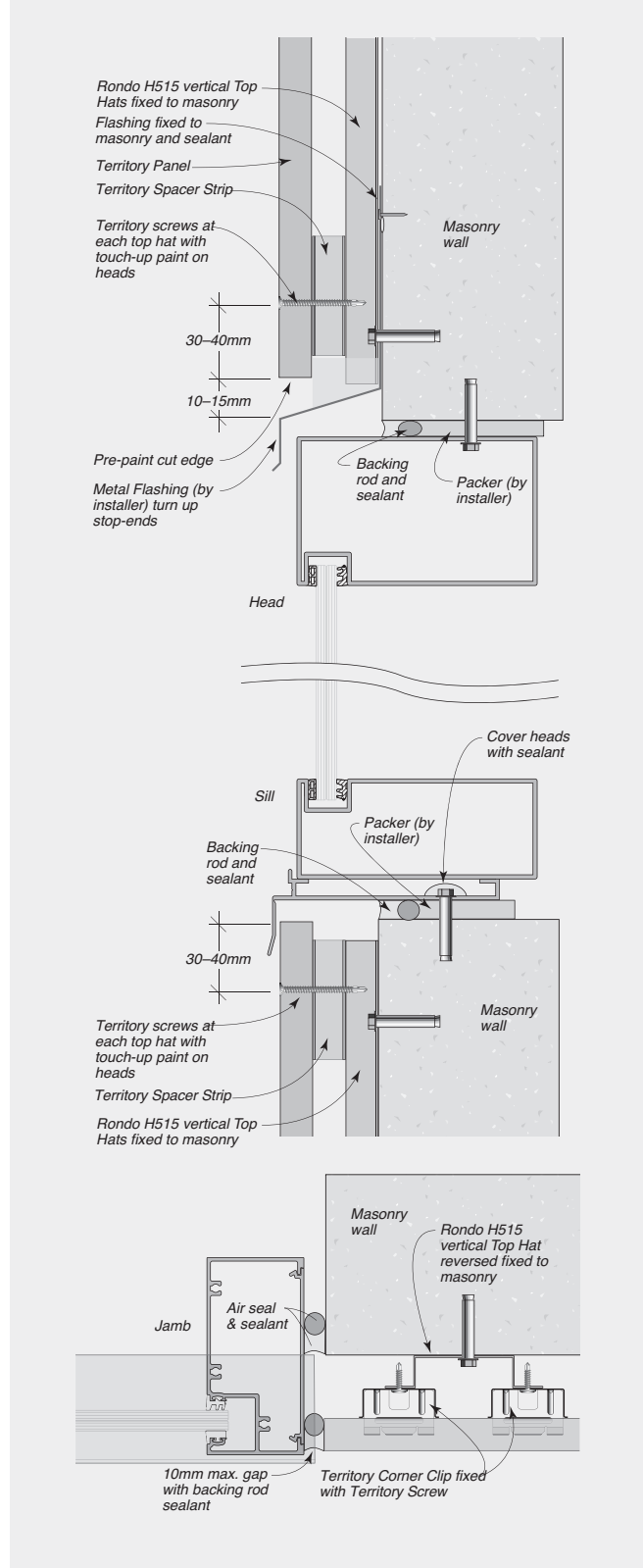

FIGURE 8.50 Generic Commercial Window for Masonry Substrates



CONSTRUCTION DRAWINGS AND DETAILS



Note: Drawings are interchangeable for timber or steel substrates with the exception of the fasteners.

GENERAL – Masonry Details

FIGURE 8.51 Typical Parapet/Roof Junction

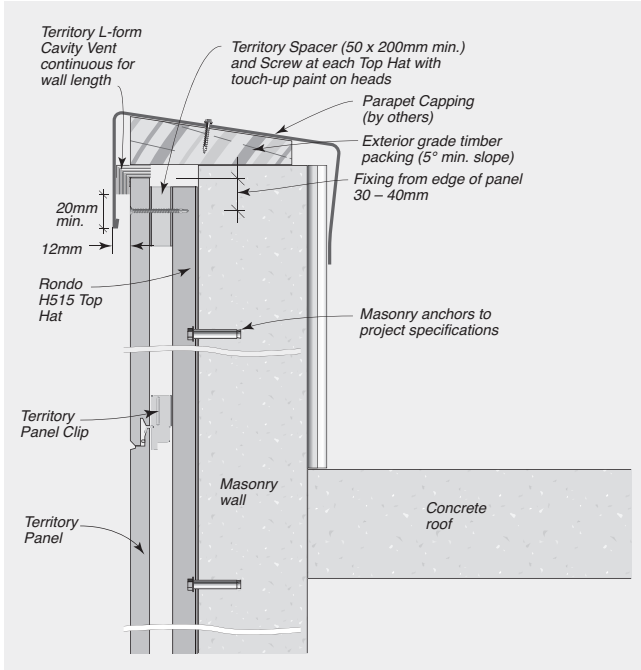
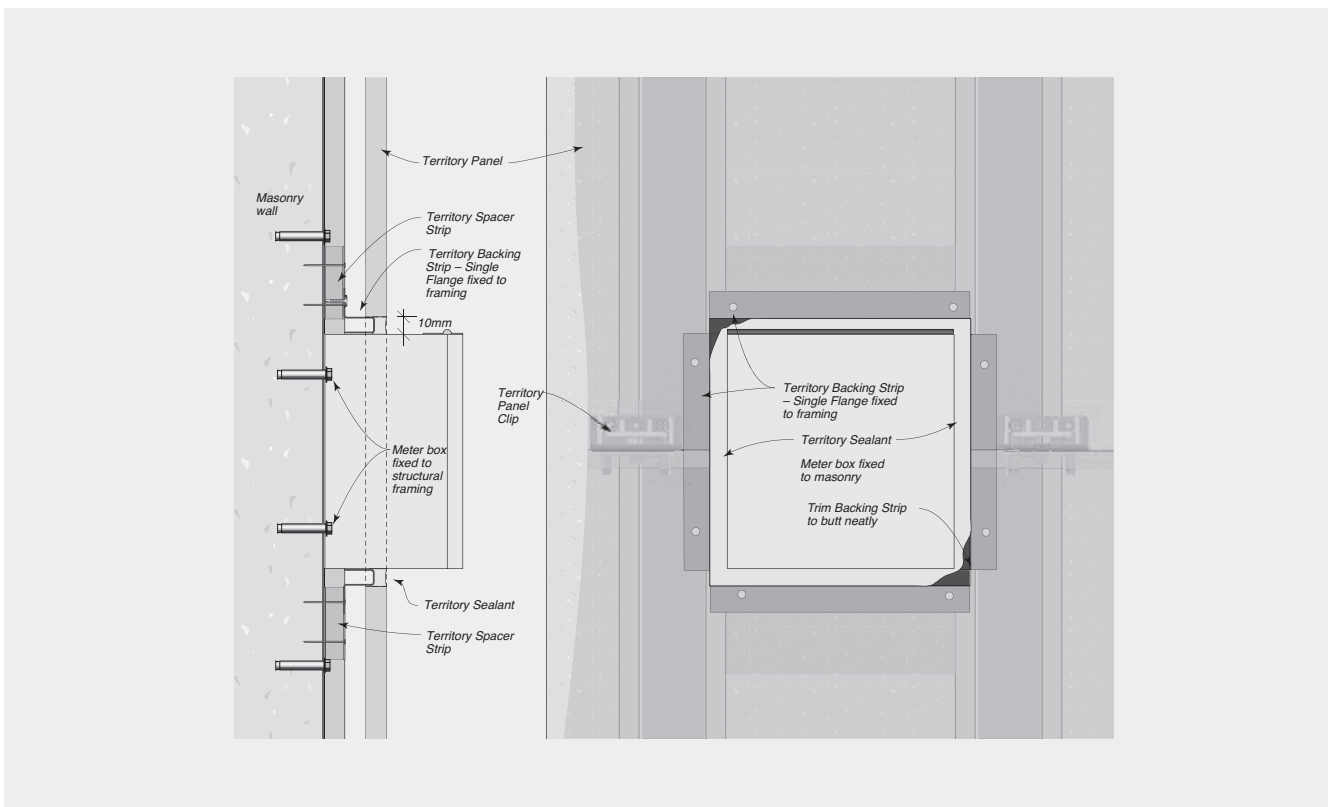

FIGURE 8.52 Typical Power/Meter Box – Mounted to Face of Framing

Note: Refer to local authority for specific meterbox installation requirements





CONSTRUCTION DRAWINGS AND DETAILS

Note: Drawings are interchangeable for timber or steel substrates with the exception of the fasteners.

AS 5113 – Base Details

FIGURE 8.53 Base Detail

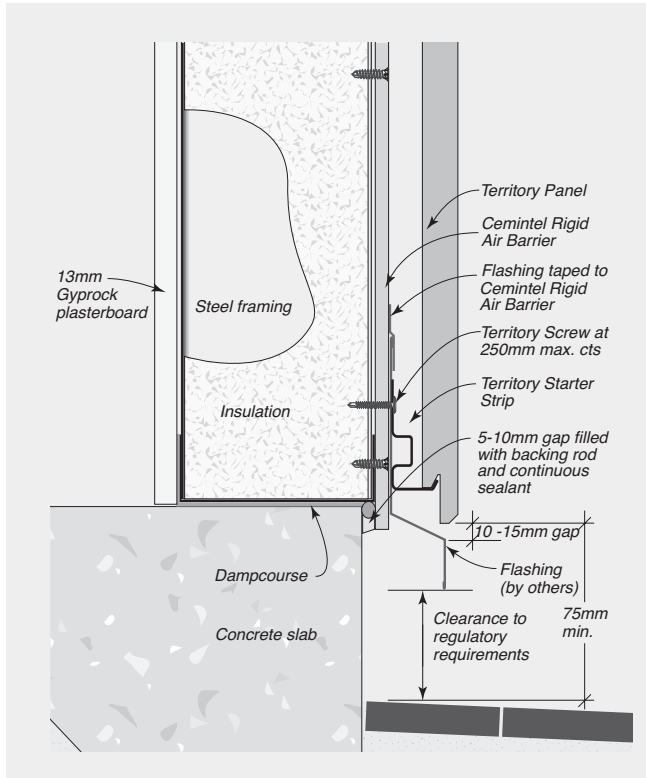

AS 5113 – Corner Details

FIGURE 8.54 External Corner Detail – with Preformed Corner

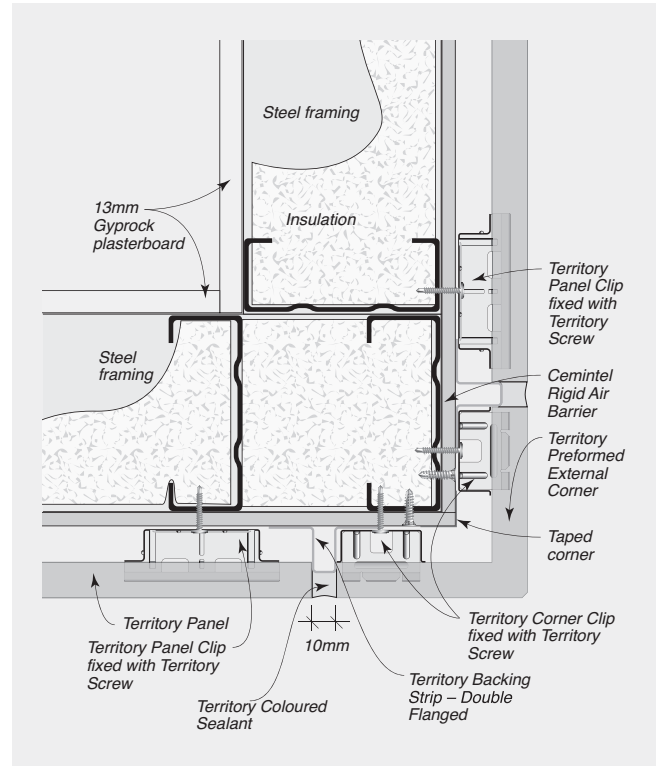
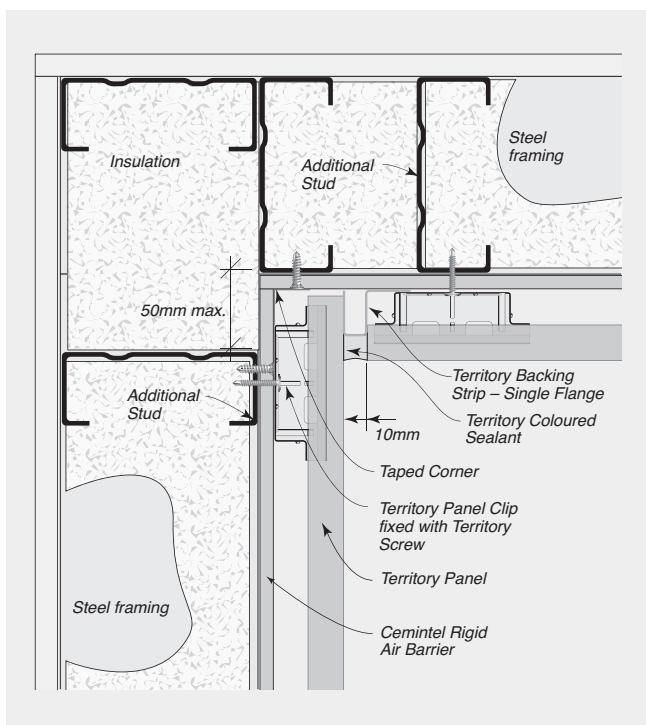

FIGURE 8.55 Internal Corner Detail



CONSTRUCTION DRAWINGS AND DETAILS



Note: Drawings are interchangeable for timber or steel substrates with the exception of the fasteners.

AS 5113 – Junction Details

FIGURE 8.56 Junction with Masonry

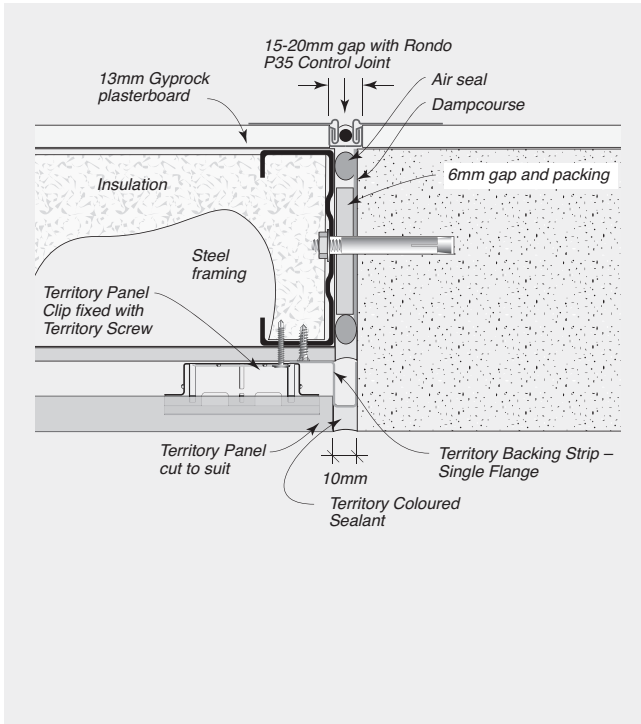

FIGURE 8.57 Junction with Masonry Offset

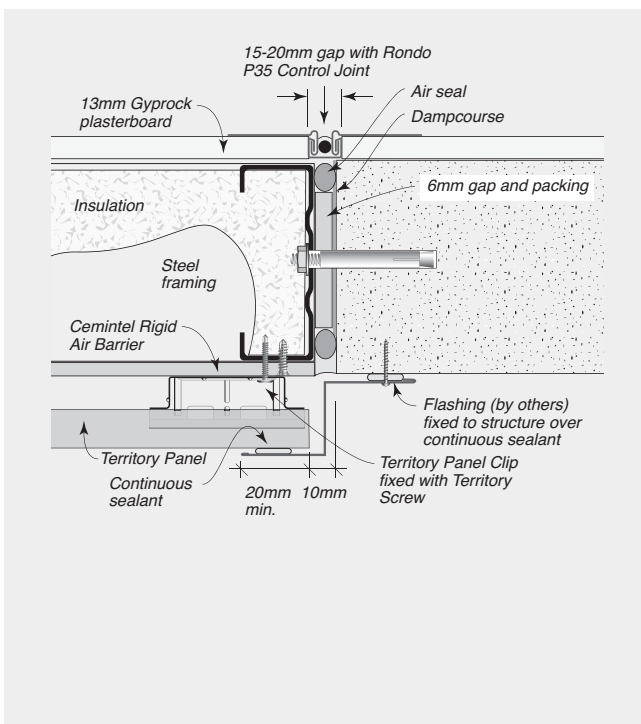
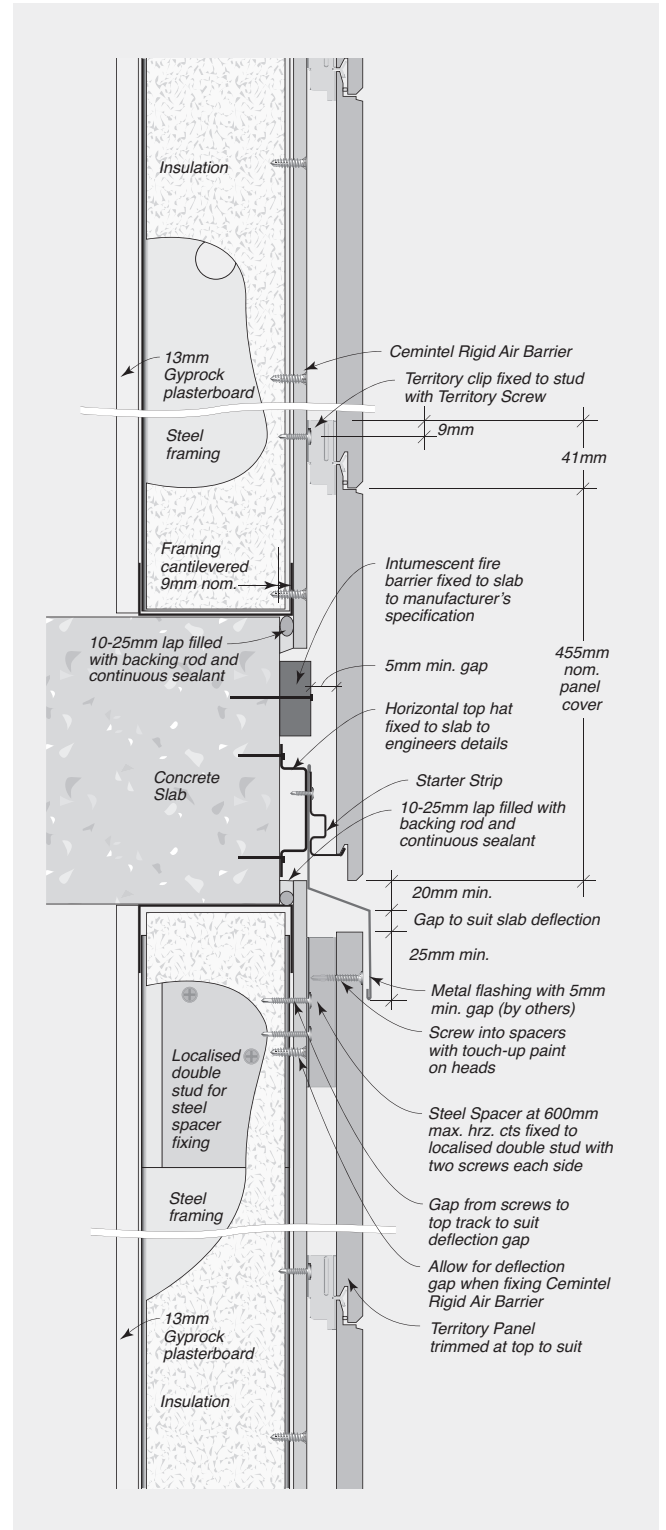

FIGURE 8.58 Edge Beam Detail





CONSTRUCTION DRAWINGS AND DETAILS

Note: Drawings are interchangeable for timber or steel substrates with the exception of the fasteners.

AS 5113 – Window Details

FIGURE 8.59 Commercial Window Frame

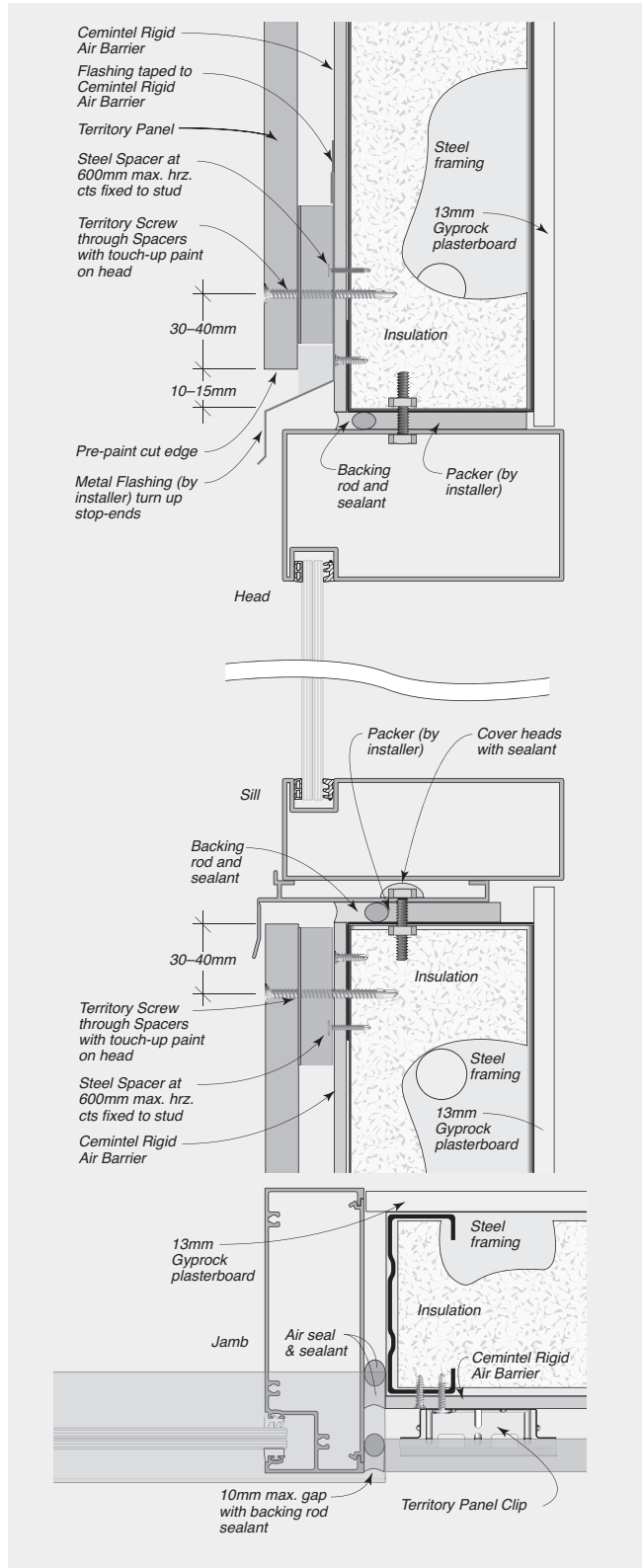
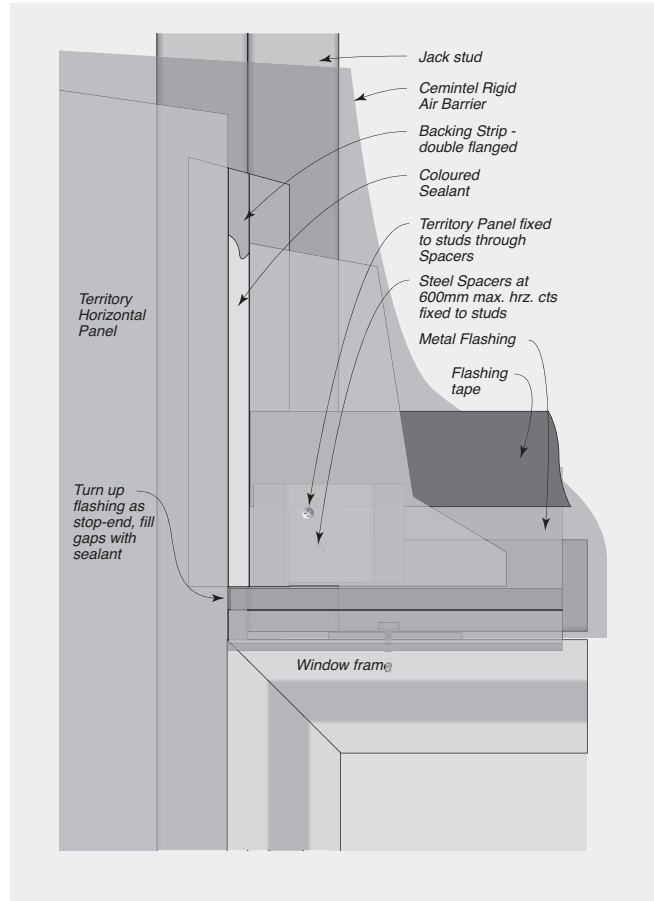

FIGURE 8.60 Window Front Elevation



CONSTRUCTION DRAWINGS AND DETAILS



Note: Drawings are interchangeable for timber or steel substrates with the exception of the fasteners.

AS 5113 - Soffit Details

FIGURE 8.61 Interstorey Junction with Territory Ceiling

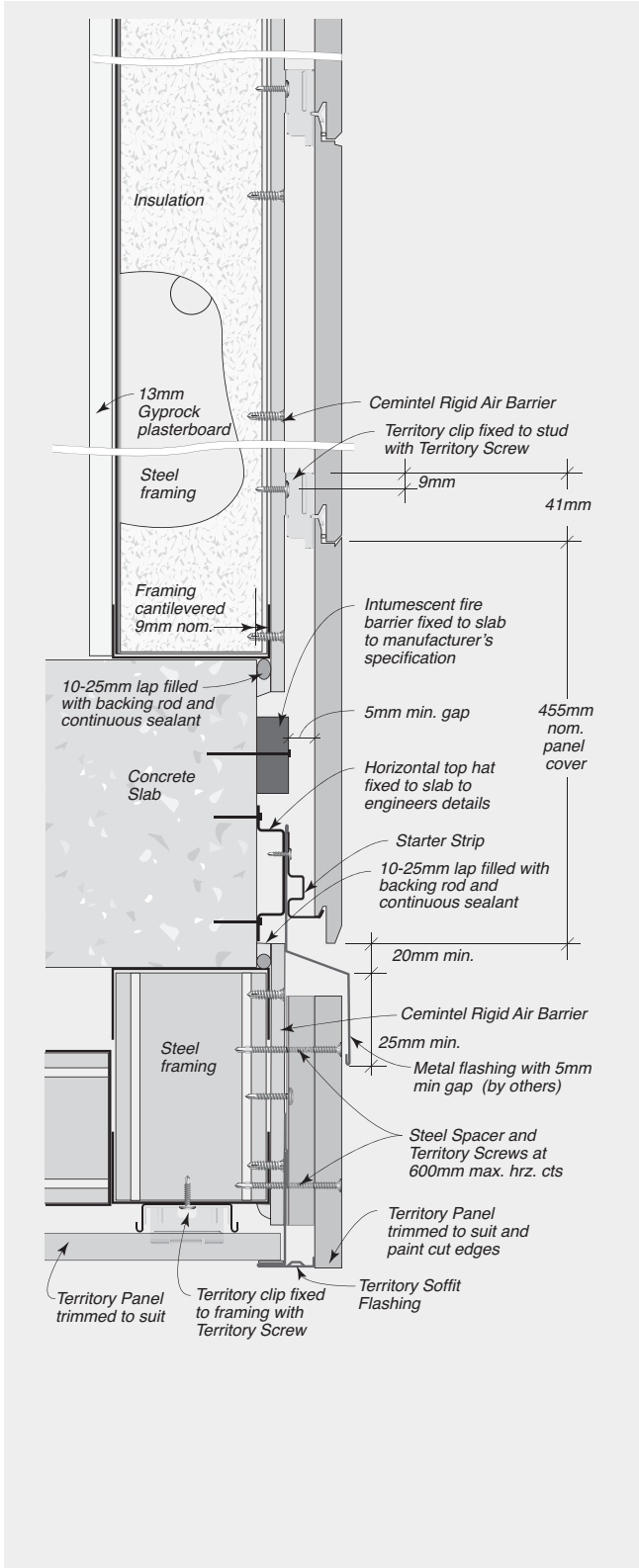
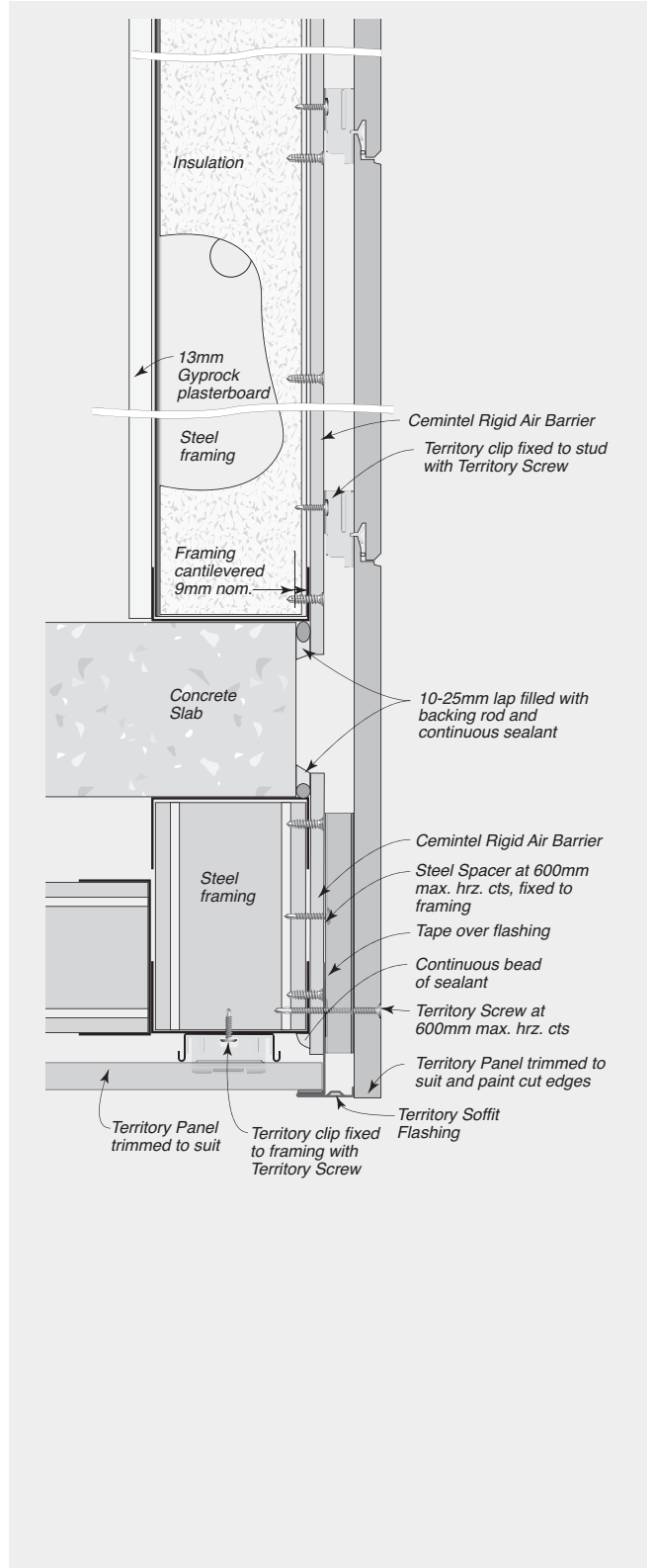

FIGURE 8.62 Territory Ceiling





CONSTRUCTION DRAWINGS AND DETAILS

Note: Drawings are interchangeable for timber or steel substrates with the exception of the fasteners.

AS 5113 – Soffit Details

FIGURE 8.63 Interstorey Junction with Metal Ceiling

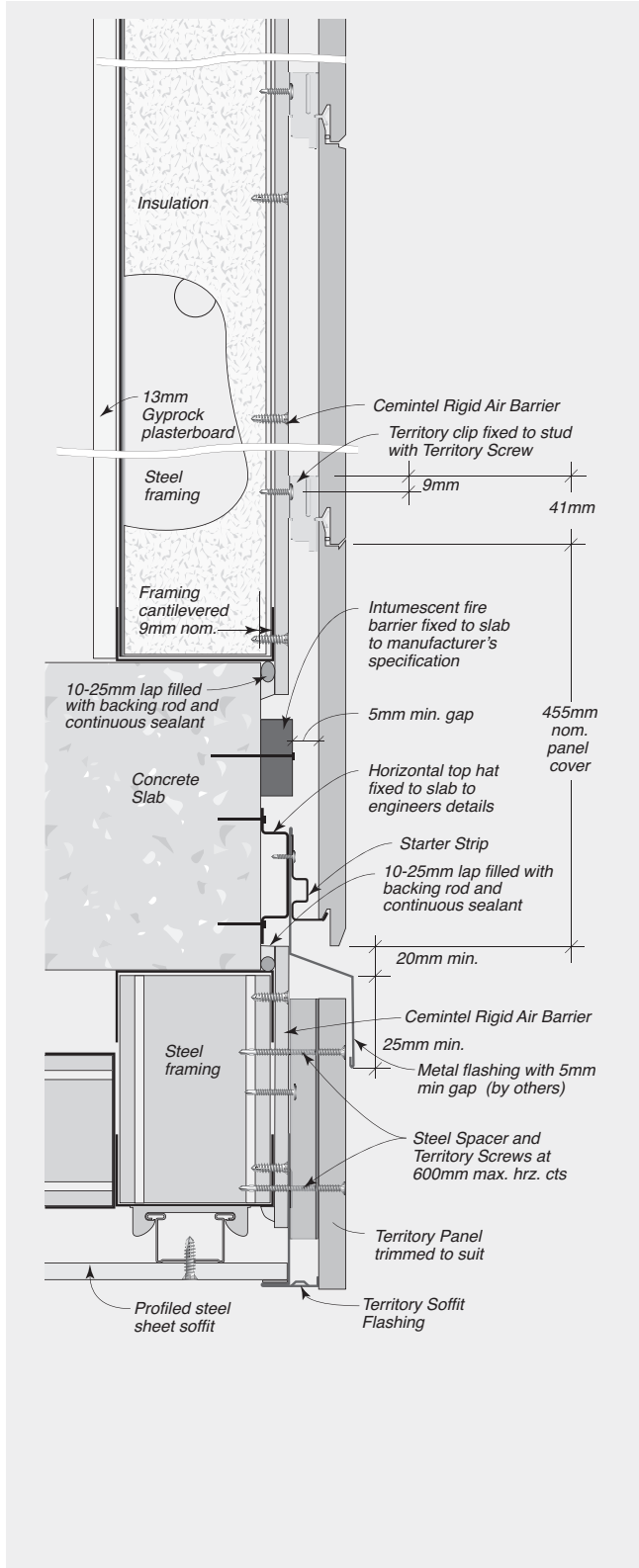
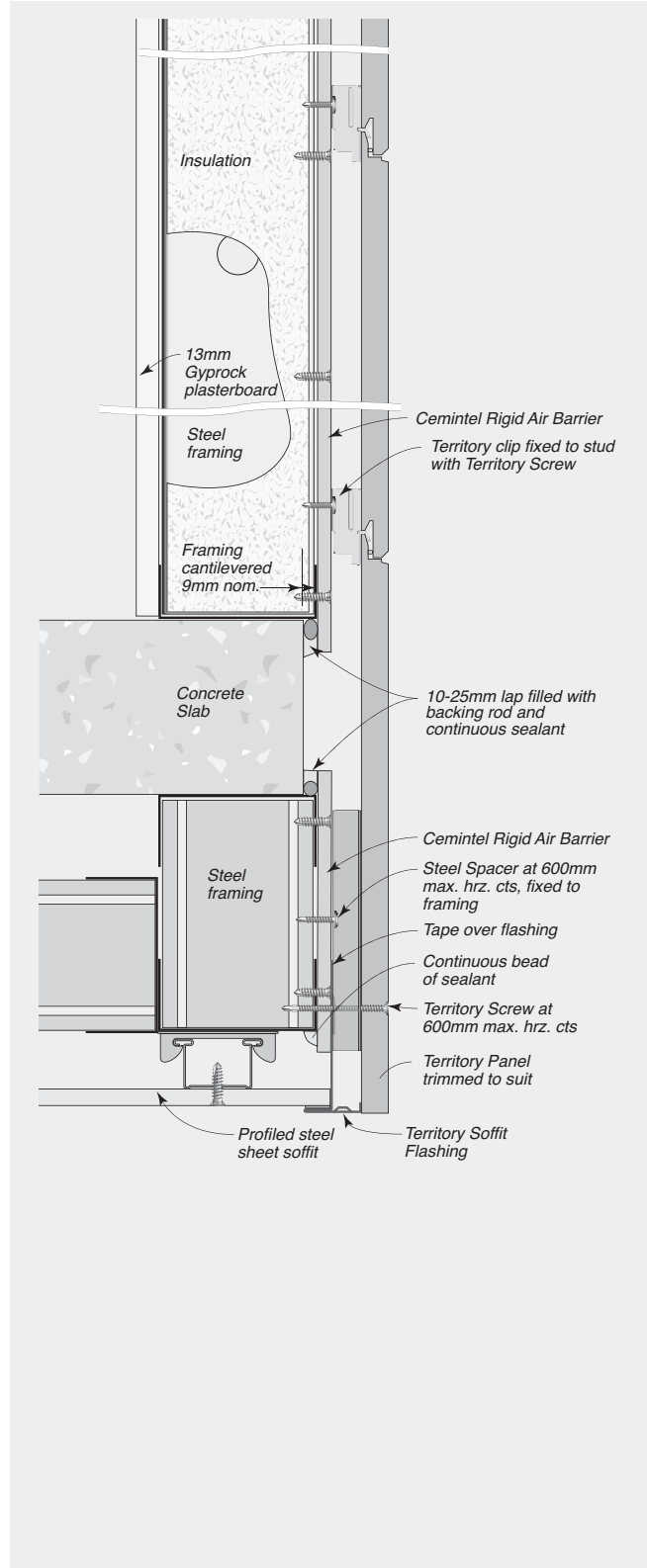

FIGURE 8.64 Metal Ceiling



CONSTRUCTION DRAWINGS AND DETAILS



Note: Drawings are interchangeable for timber or steel substrates with the exception of the fasteners.

AS 5113 - Soffit Details

FIGURE 8.65 Interstorey Junction with Composite Ceiling

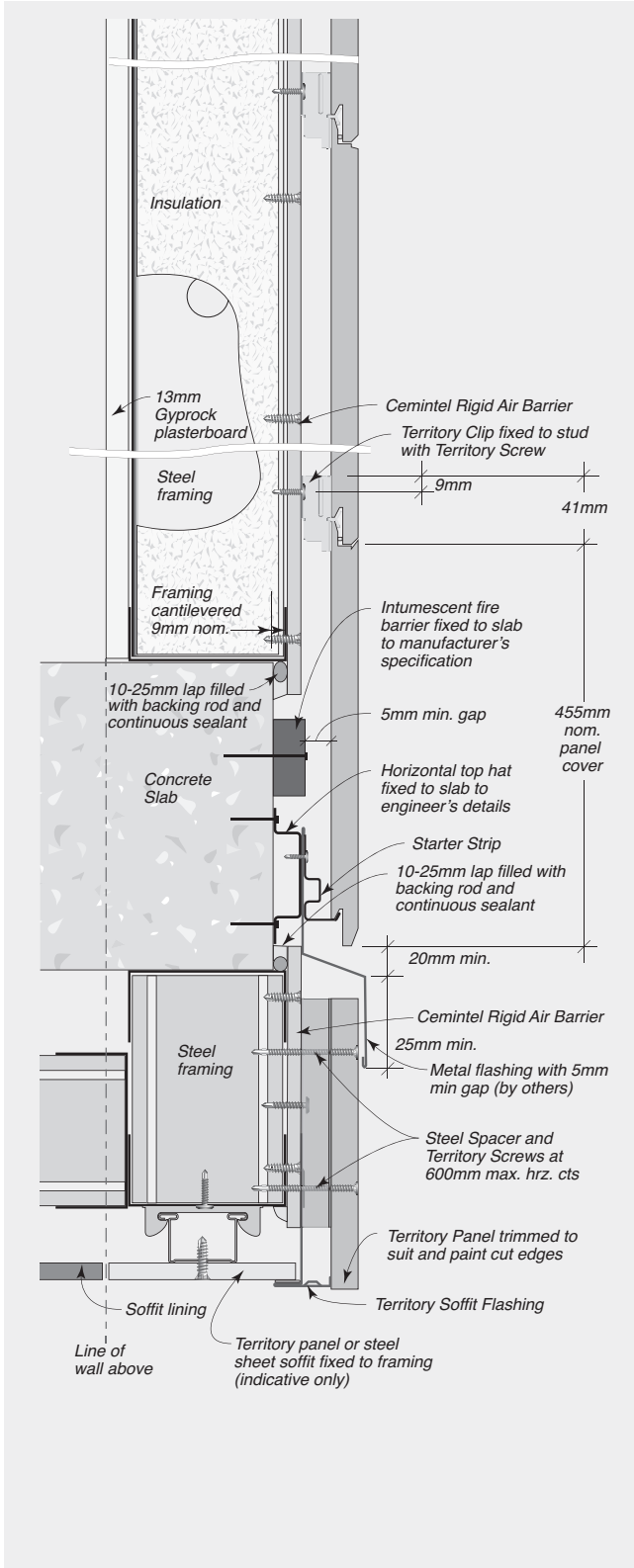
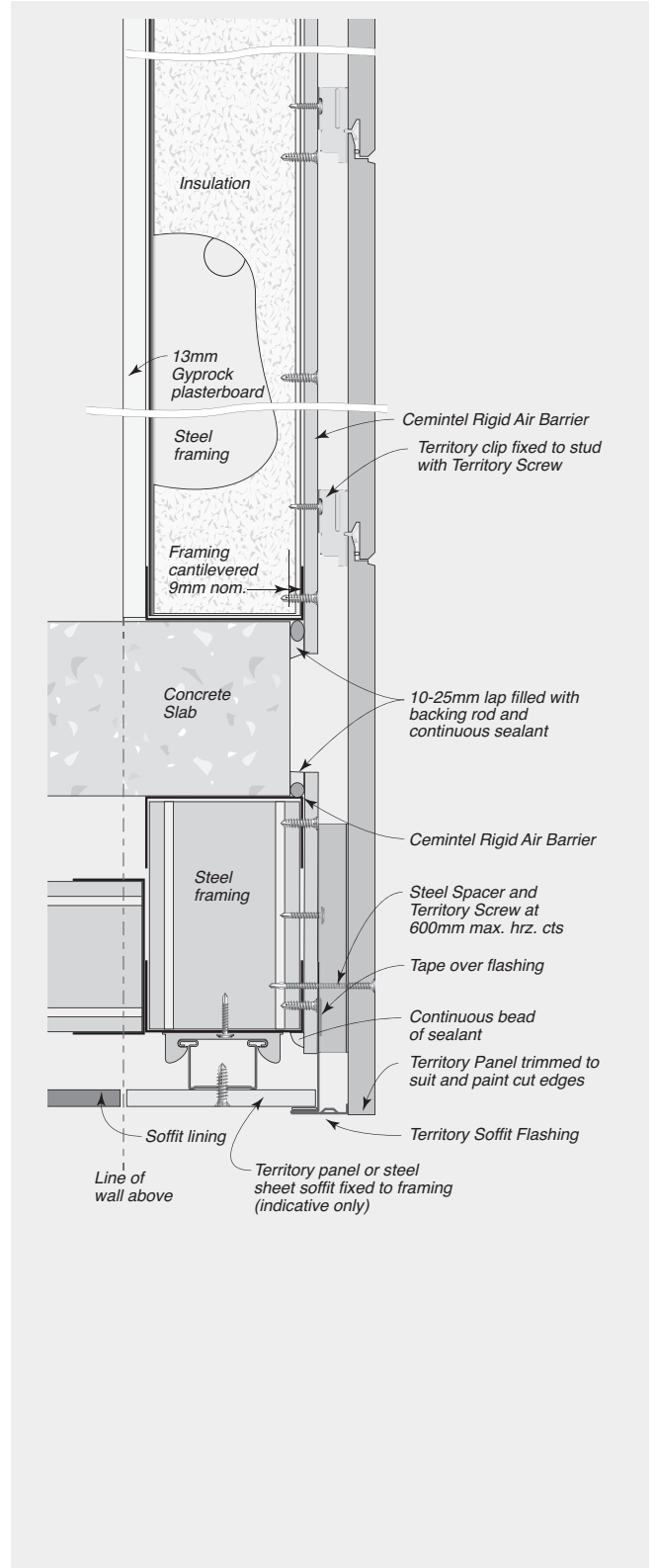

FIGURE 8.66 Composite Ceiling





CONSTRUCTION DRAWINGS AND DETAILS

Note: Drawings are interchangeable for timber or steel substrates with the exception of the fasteners.

AS 5113 – Parapet Details

FIGURE 8.67 Parapet Details – Horizontal Steel Framing

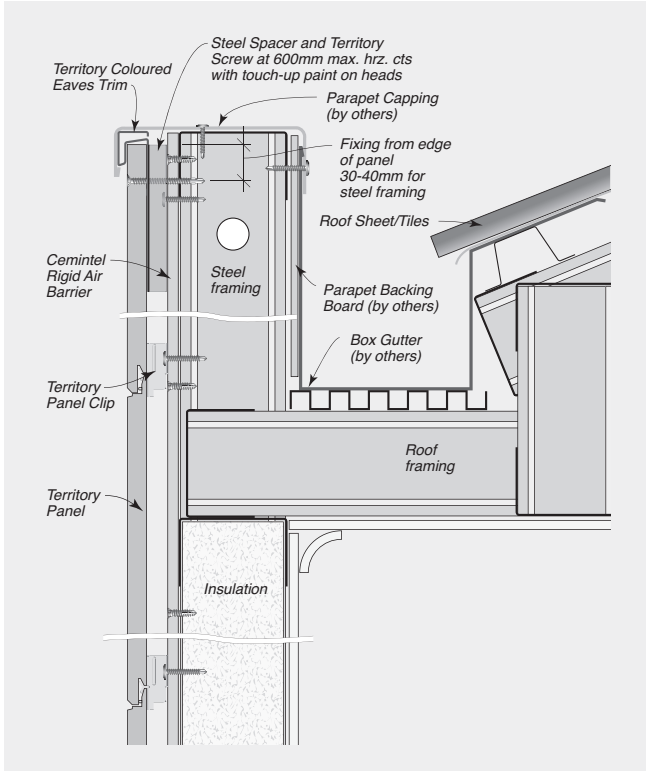

AS 5113 – Door Details

FIGURE 8.68 Dowell Sliding Door – Steel Framing

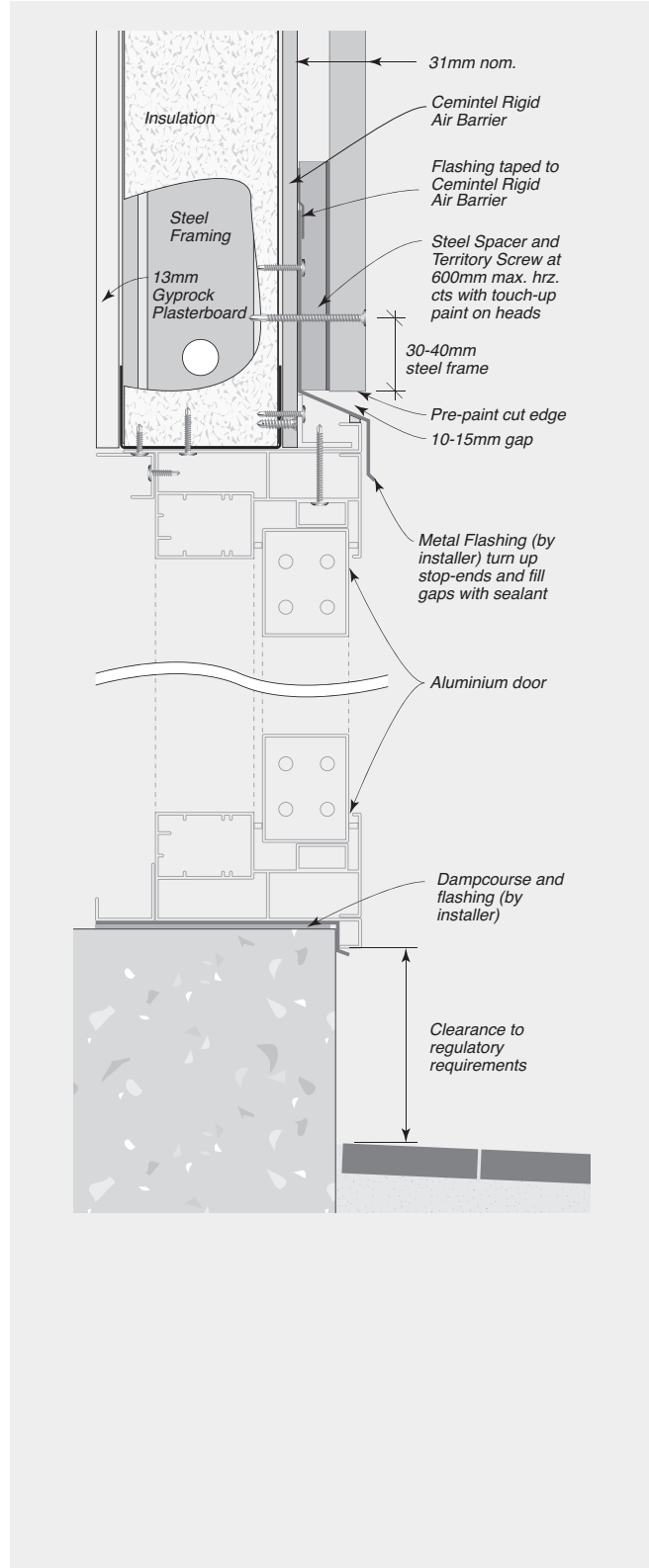

CONSTRUCTION DRAWINGS AND DETAILS



Note: Drawings are interchangeable for timber or steel substrates with the exception of the fasteners.

Soft Air Barrier

FIGURE 8.69 Typical Installation Overview – Soft Air Barrier

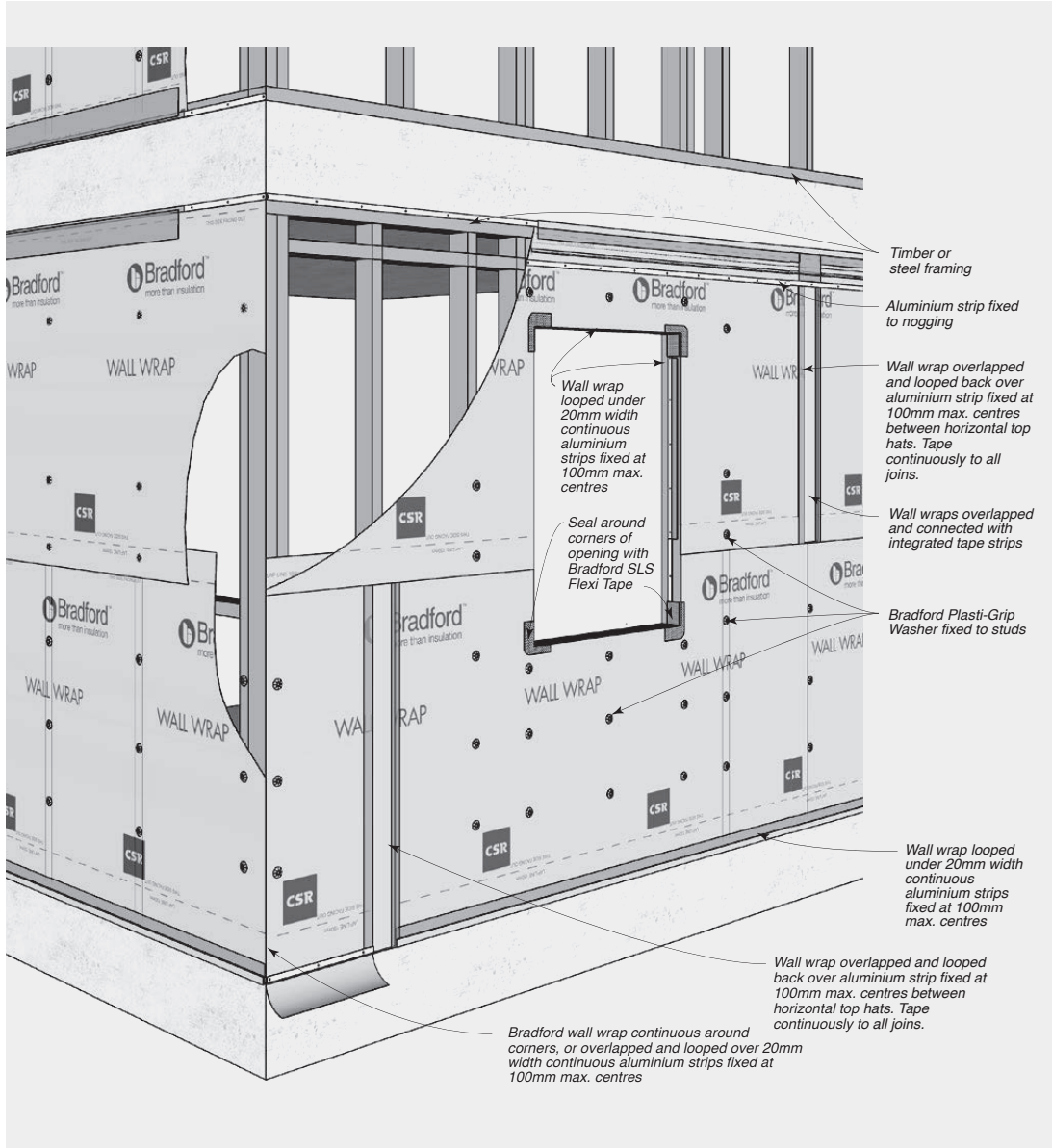



CONSTRUCTION DRAWINGS AND DETAILS

Note: Drawings are interchangeable for timber or steel substrates with the exception of the fasteners.

Soft Air Barrier

FIGURE 8.70 External Corner – Wall Wrap Continuous

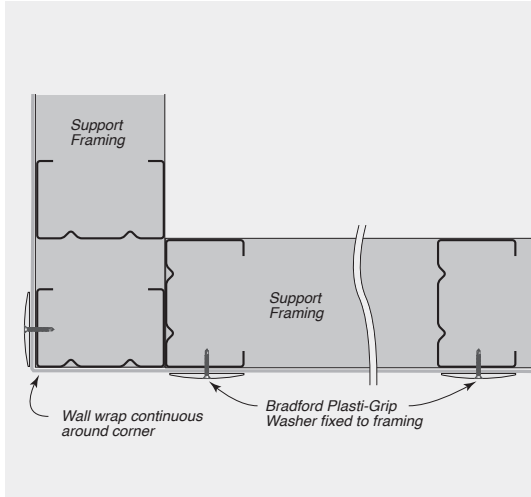

FIGURE 8.71 External Corner – Wall Wrap Overlapped

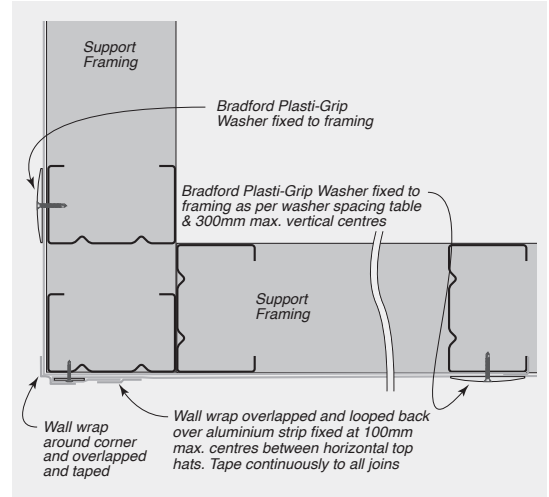

FIGURE 8.72 Internal Corner – Wall Wrap Continuous

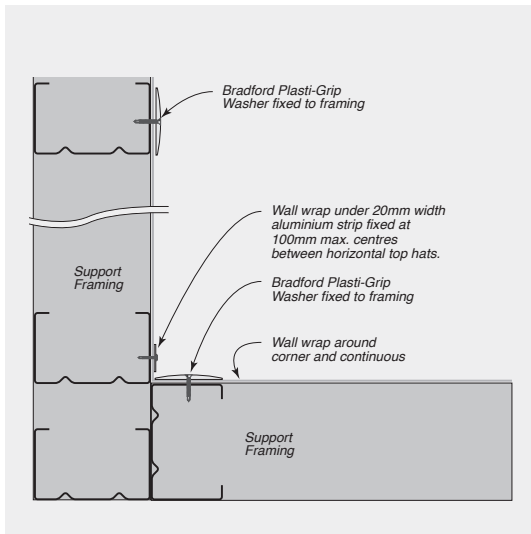

FIGURE 8.74 Internal Corner – Wall Wrap Overlapped

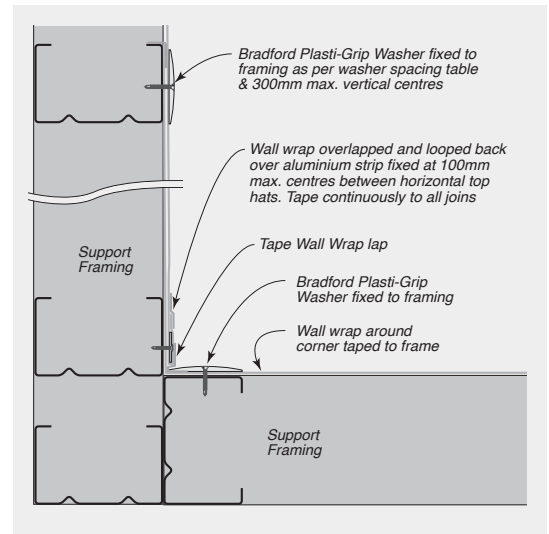
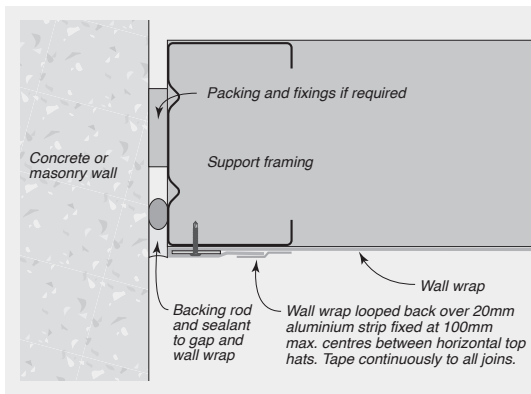

FIGURE 8.73 Abutment to Concrete or Masonry Wall



CONSTRUCTION DRAWINGS AND DETAILS



Note: Drawings are interchangeable for timber or steel substrates with the exception of the fasteners.

Soft Air Barrier

FIGURE 8.75 Wall Wrap Installation to Wall, Soffit and Base

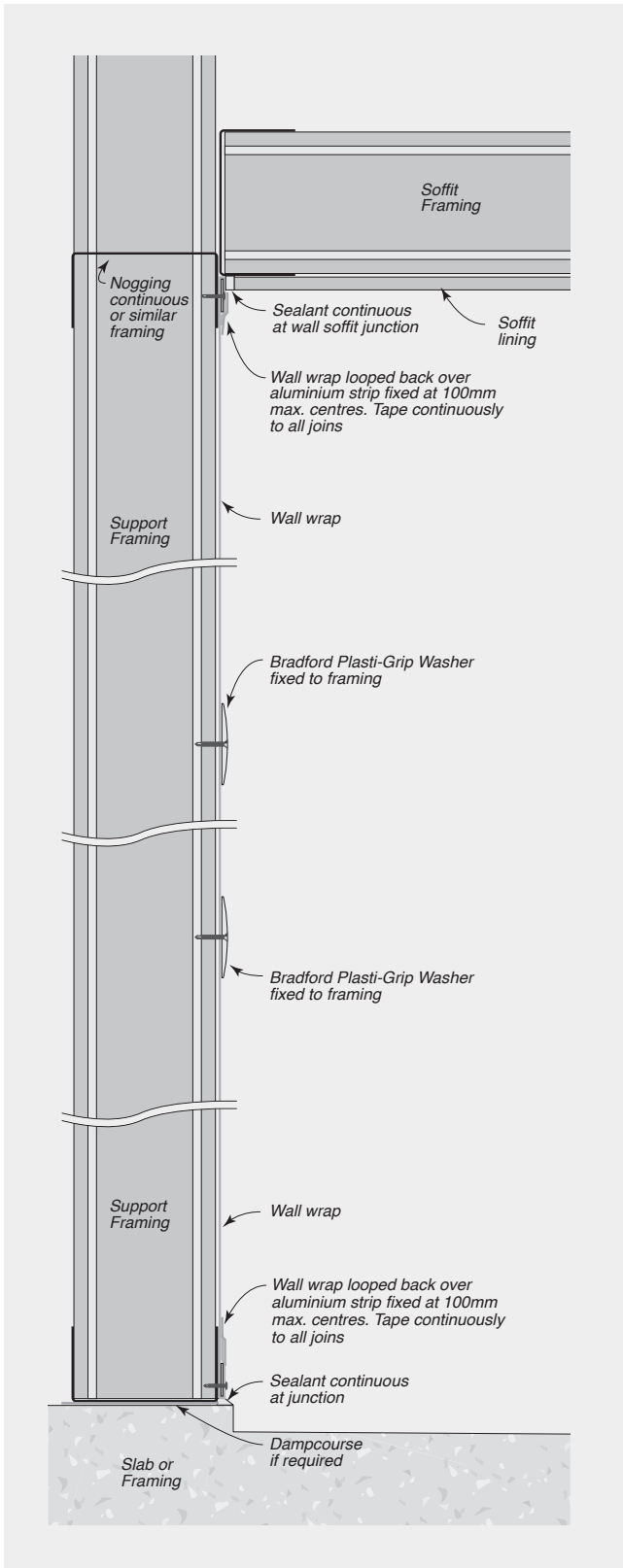
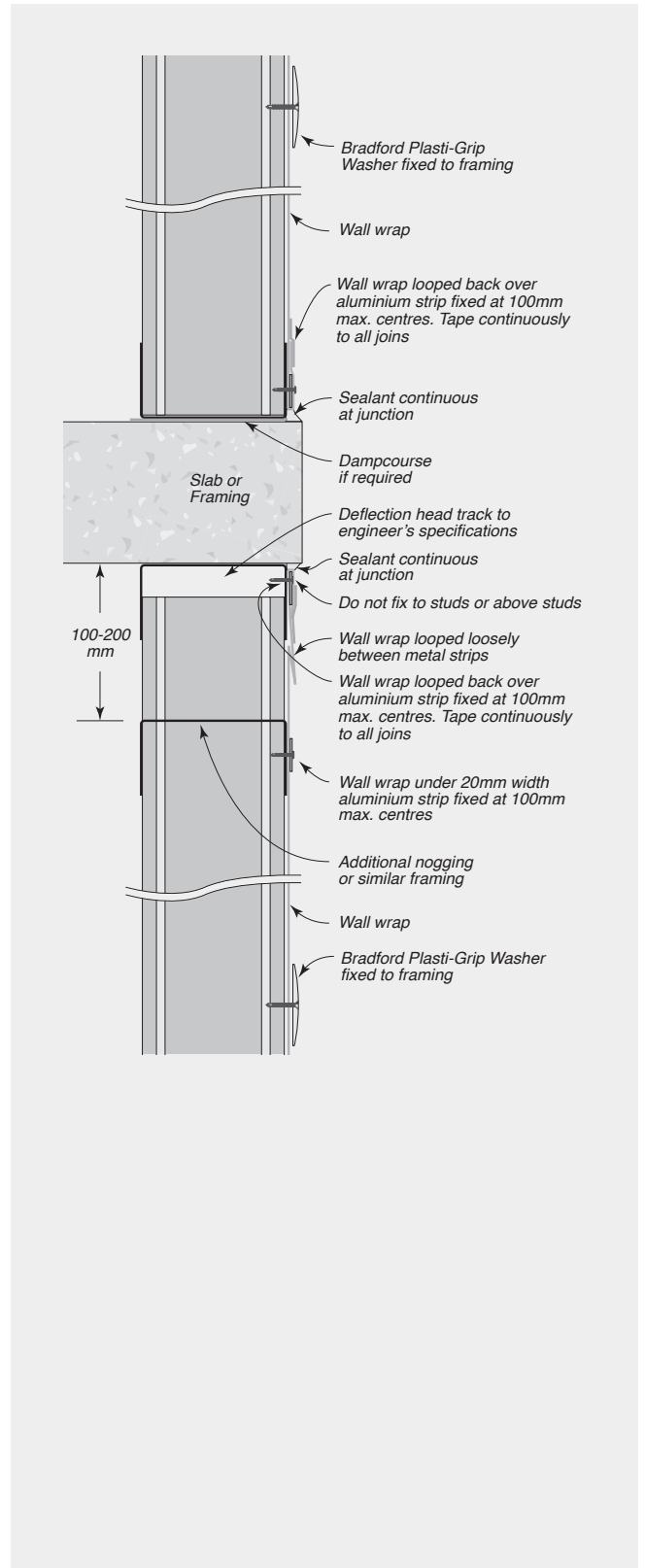

FIGURE 8.76 Wall Wrap Installation at Intermediate Level Junction - Non-loadbearing Steel Framing With Deflection Head





CONSTRUCTION DRAWINGS AND DETAILS

Note: Drawings are interchangeable for timber or steel substrates with the exception of the fasteners.

Soft Air Barrier

FIGURE 8.77 Vertical Wall Wrap Junction – Overlapped Double Strip Join

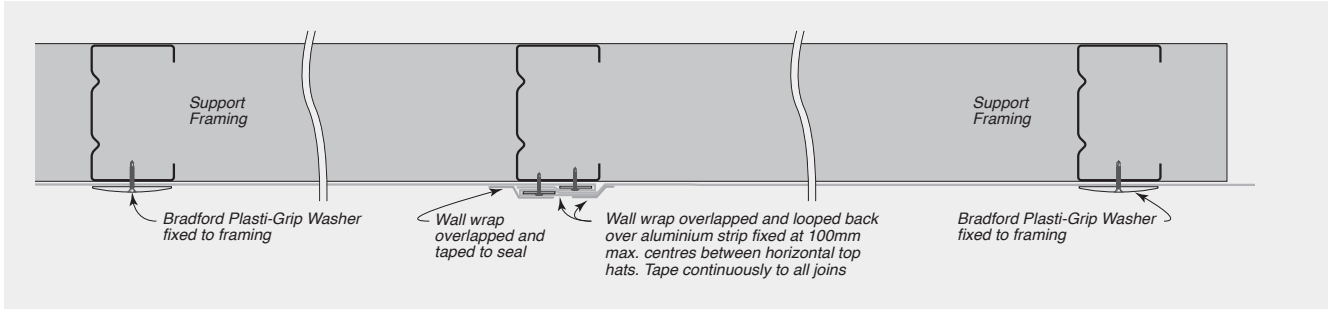

FIGURE 8.78 Vertical Wall Wrap Junction – Overlapped Single Strip Join

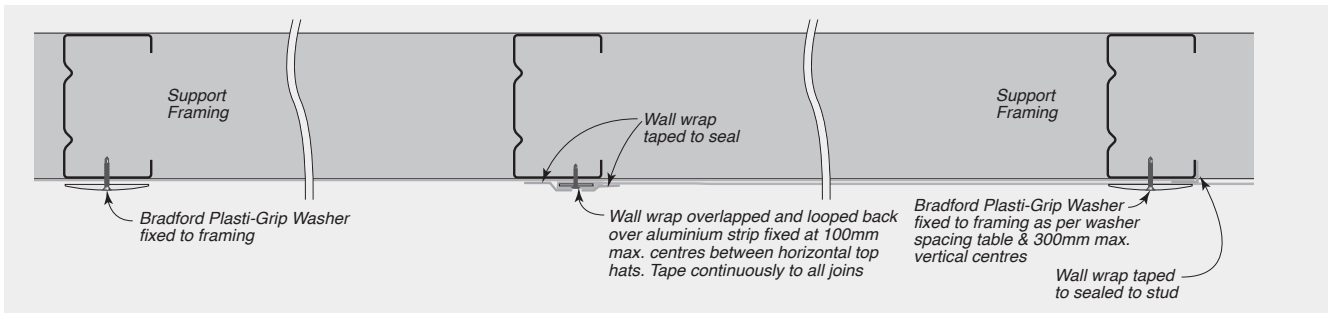

FIGURE 8.79 Vertical Wall Wrap Junction – At Control Joint

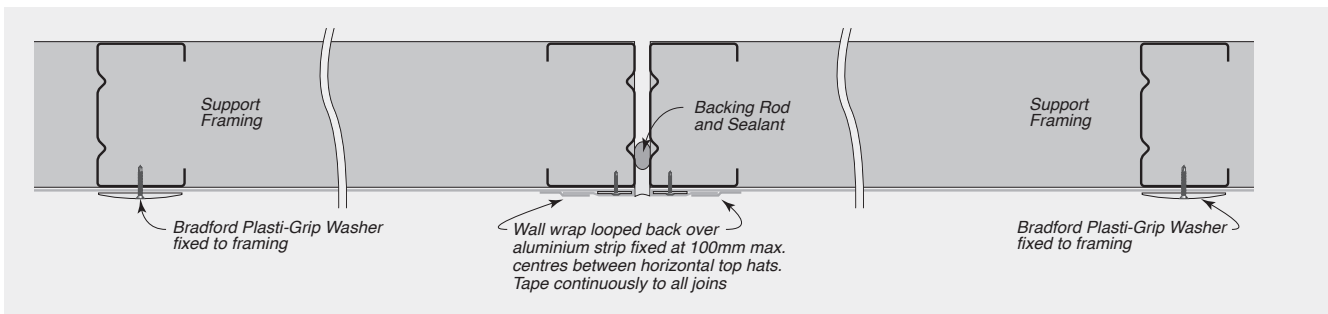
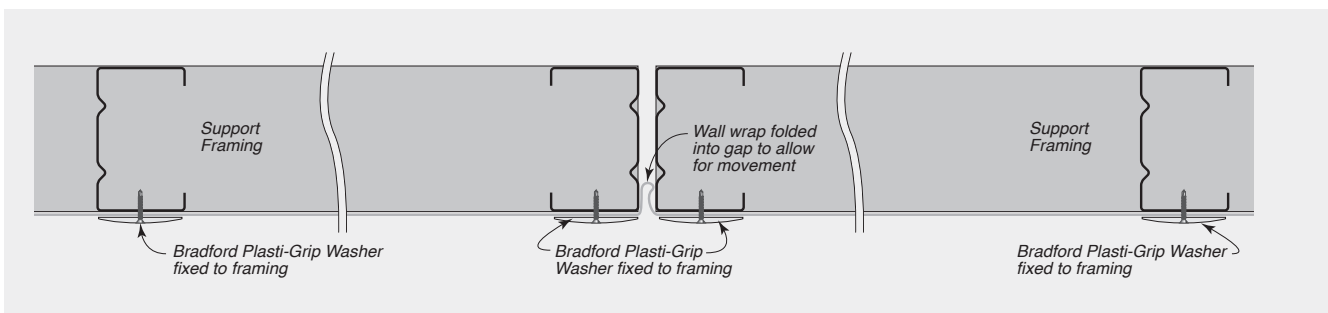

FIGURE 8.80 Vertical Wall Wrap Junction – No Lap Double Washer



CONSTRUCTION DRAWINGS AND DETAILS



Note: Drawings are interchangeable for timber or steel substrates with the exception of the fasteners.

Soft Air Barrier

FIGURE 8.82 Wall Wrap Installation at Window/Door Opening

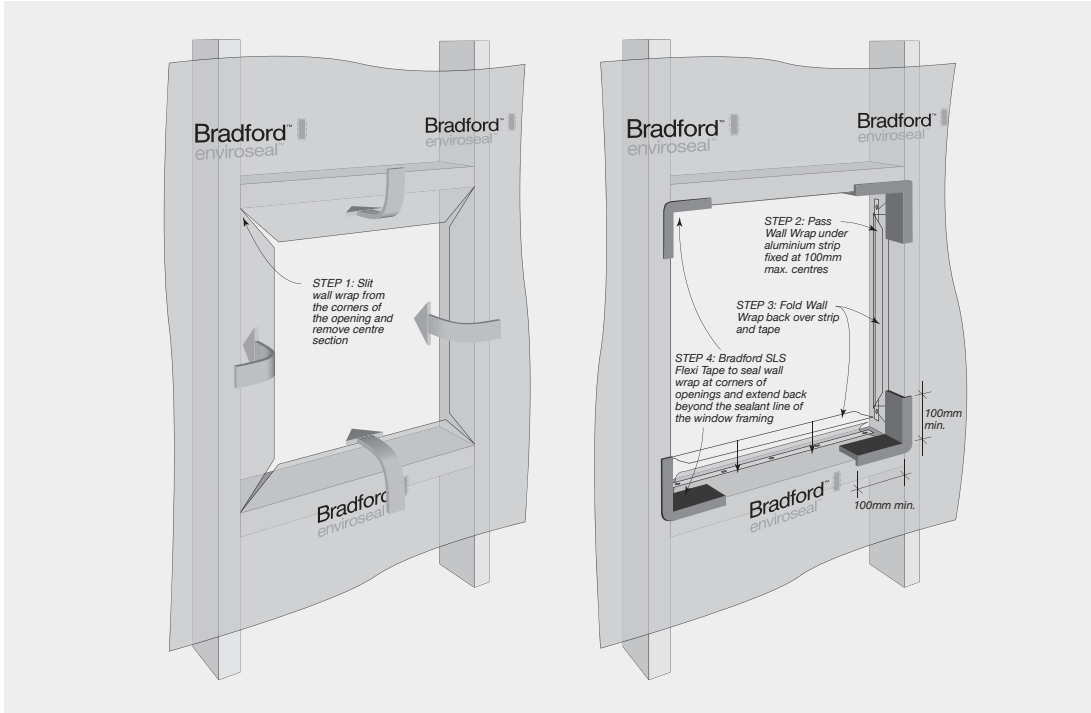
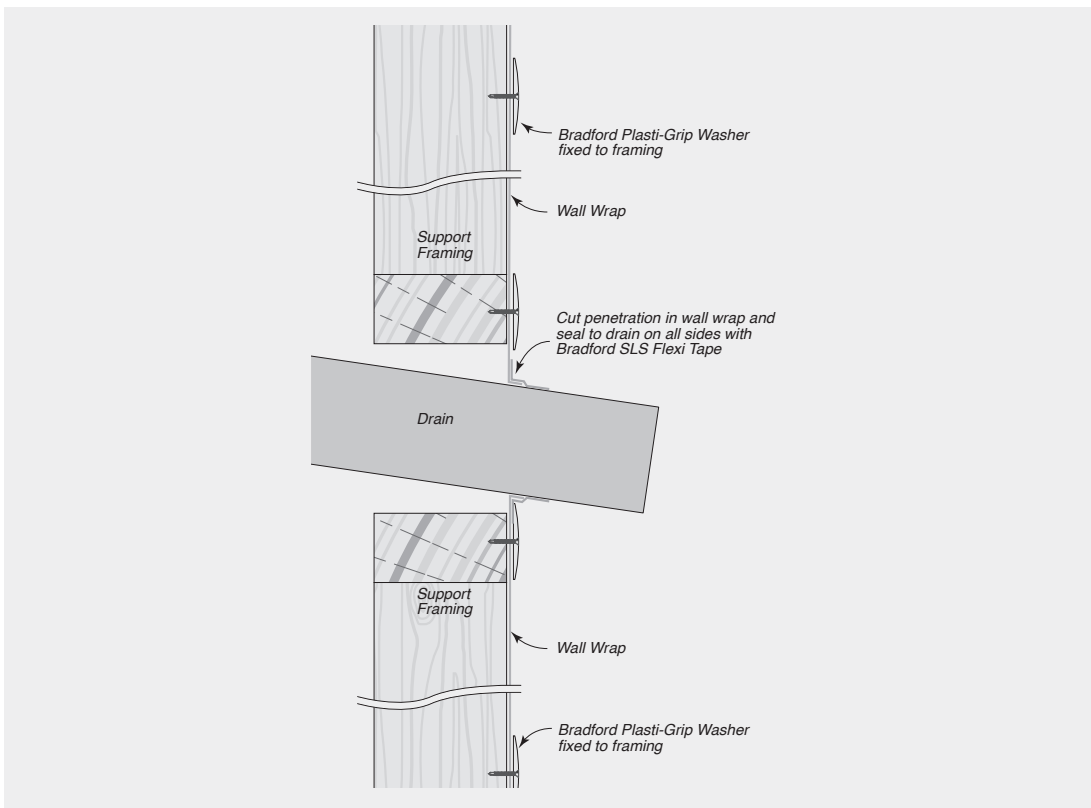

FIGURE 8.81 Wall Wrap Installation at Drain Penetration – Timber or Steel Framing





CONSTRUCTION DRAWINGS AND DETAILS

Note: Drawings are interchangeable for timber or steel substrates with the exception of the fasteners.

Soft Air Barrier

FIGURE 8.83 Wall Wrap Installation at Parapet Junction – Timber or Steel Framing

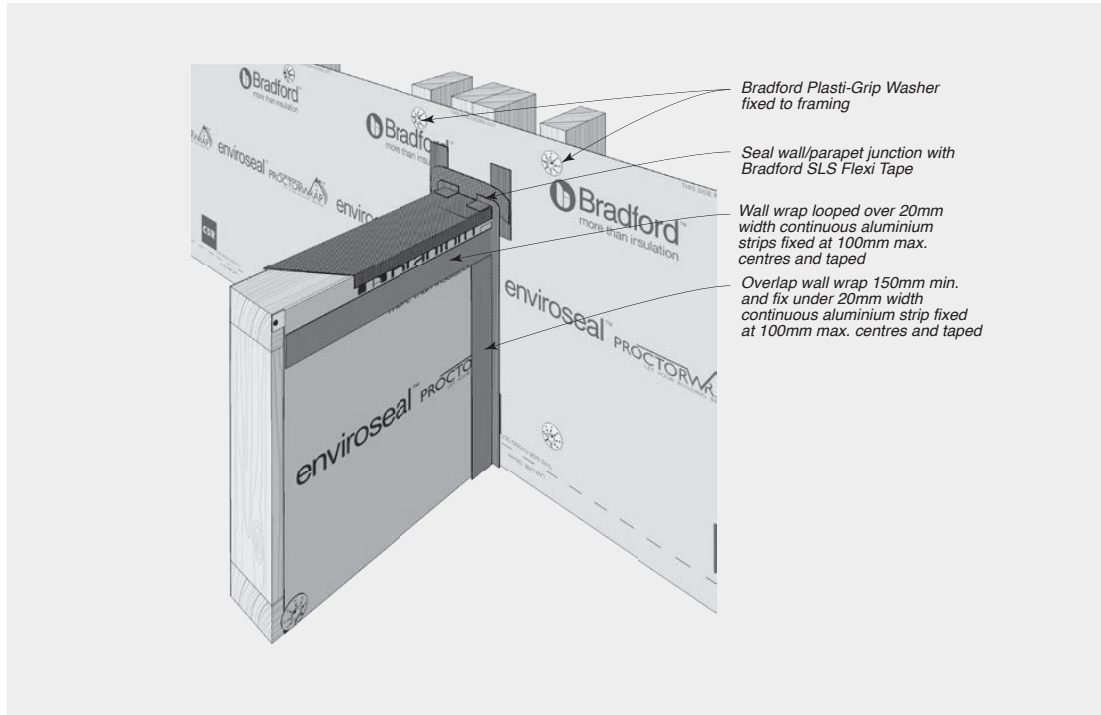



**SAFETY, HANDLING,
GENERAL CARE + WARRANTY**



SAFETY, HANDLING, GENERAL CARE + WARRANTY

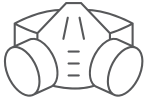

Health, Safety and Personal Protection Equipment (PPE)

Fibre Cement contain silicas that are harmful if inhaled. Protective clothing and breathing equipment should be worn when cutting products.

When cutting, drilling or grinding fibre cement panels using power tools, always ensure the work area is properly ventilated.

An approved dust mask (AS/NZS 1715 and AS/NZS 1716) and safety glasses (AS/NZS 1337) must be worn. Cemintel recommends that hearing protection also be worn.

Safety Data Sheet information is available at www.cemintel.com.au



Managing Respirable Crystalline Silica Dust

Crystalline Silica is everywhere. It is found naturally in stone, rocks, sand, gravel and clay. Sand is one of the raw materials in Fibre Cement. Respirable Crystalline Silica dust is the fine dust that's created when you use power tools to cut, drill, grind, chip or sand materials and products that contain crystalline

silica. This dust is of concern due to its size as it gets caught deep in your lungs and can cause long term damage.

IF YOU USE THE CORRECT SAFETY EQUIPMENT AND PPE, FIBRE CEMENT IS SAFE TO USE.

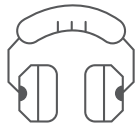

Cemintel Safety Requirements

1 - Cut Outdoors*	The ventilation outdoors is greater than that indoors, and therefore should reduce exposure.
2 - Use On-Tool Dust Extraction	Use on-tool dust extraction when using power tools to drill and cut Fibre Cement, with a vacuum that contains a HEPA M Class filter.
3 - Correct Saw and Blade	Use a plunge saw with a specifically designed Fibre Cement blade.
4 - Don't Sweep, Vacuum instead	When completing your work vacuum with a HEPA M Class filter, rather than a broom as sweeping creates more dust.
5 - Use Correct Respirator	Use a half face P1 or P2 respirator. It is essential that the respirators are Fit Tested and workers are cleanly shaven to obtain a good seal.

* Even though not recommended, indoor cutting can be completed when using an onsite cutting room with exhaust ventilation and a M class filter at a minimum, on-tool dust extraction with a vacuum with a HEPA M Class filter, a Full Face P2 respirator and conducting local occupational and static air monitoring to validate effectiveness of control measures.

Handling & General Care

Storage

All Territory panels must be stacked flat, clear of the ground and supported at 300mm maximum centres on a level platform. Panels must be kept dry, preferably stored inside the building. Panels must be dry prior to fixing, hence if it is necessary to store outside, the product must be protected from the weather.

Handling

Territory panels and corners are pre-finished products and must be treated with care during handling so as to avoid damage to edges, ends and pre-finished surface. Panels should be carried horizontally on edge by two people.

As the Territory range is a pre-finished product, consideration should be given to the activity of other tradespeople, in particular, a brick cleaner. It is highly recommended that installation of Territory should always be held off until the process of brick cleaning has been completed so as to avoid damage.

Cutting

Panels should be cut from the back using a power saw. Cemintel recommends using the FESTOOL TS 55 EBQ Plunge Cut Saw or Makita Plunge Saw with guide rail and appropriate blade. All exposed cut edges such as the window heads and roof junctions must be sealed with Cemintel edge sealer. Refer to 'Components + Accessories' table for appropriate materials.

Mitreing of Panels

It is not recommended to mitre panels as this can cause delamination of the face.

Face Fixing of Panels

At face fixing points, all panels must be supported by a Spacer Strip of 200mm minimum length. Panels must be pre-drilled to accept nails. Use a 2.5mm drill bit and drill from the front. Nail/screw heads should finish flush with the panel surface. All visible nail/screw heads should be neatly covered with primer and coloured painted used sparingly. Do NOT use sealant on nail heads.

Penetrations

Penetrations in panels may be cut or drilled prior to installation. Cut from the back or drill from the front. Cut penetrations oversize by 8-10mm all around. Mask, prime and fill gaps with sealant in accordance with recommended methods and products.

Bevelled Edges

The top edge of panels at window sill level may require bevelling. Cemintel recommends using the FESTOOL DSC-AGP 125 Diamond Blade Cutting & Grinding Tool.

Warranty

The Cemintel Territory panels have a product warranty of 10 years.

The full Cemintel Territory product warranty is available for download at cemintel.com.au

NOTES

A large grid of small dots for taking notes, covering the majority of the page below the 'NOTES' header.



Our Offices

Sydney

376 Victoria Street
Wetherill Park NSW 2164

Adelaide

Lot 100 Sharp Court
Mawson Lakes SA 5095

Darwin

Cnr Stuart Highway
& Angliss Street
Berrimah NT 0828

Melbourne

277 Whitehall Street
Yarraville VIC 3013

Perth

19 Sheffield Road
Welshpool WA 6106

Brisbane

768 Boundary Road
Coopers Plains QLD 4108

Hobart

11 Farley Street
Derwent Park TAS 7009

cemintel.com.au

1300 236 468

For Design and Technical Support:

DesignLINK – 1800 621 117

Cemintel is a trading entity of CSR Building Products Limited (ACN 008 631 356).

Disclaimer: The products referred to in this document have been manufactured by or on behalf of CSR Building Products Limited ("CSR") to comply with the National Construction Code and any relevant Australian Standards. While any design or usage guidelines set out in this document have been prepared in good faith by CSR, they are of a general nature only and are intended to be used in conjunction with project specific design and engineering advice.

It is the responsibility of the customer to ensure that CSR's products are suitable for their chosen application, including in respect of project-specific matters such as, but not limited to structural adequacy, acoustic, fire resistance/combustibility, thermal, and weatherproofing requirements. All information relating to design/installation/application of these products is offered without warranty and no responsibility can be accepted by CSR for errors and omissions, or for any use of the relevant products not in accordance with CSR's technical literature or any other relevant industry standards. For current technical and warranty documentation relating to Cemintel's products, visit Cemintel's website at www.cemintel.com.au.

08/2024